



CHIMENEA INDIVIDUAL

Sistema EW - ECO 316

Chimenea modular metálica para evacuación de humos y gases de los productos de la combustión de simple pared fabricada en acero inoxidable.

MATERIAL

AISI 316L

ACABADO EXTERIOR

Brillante

Colores RAL hasta 200°C (consultar precios)

ESPESORES (mm)

0,4 - 0,5 - 0,6 - 0,8 (según el diámetro)

DIÁMETROS DISPONIBLES (mm)

Ø80 a Ø800

SISTEMA DE UNIÓN

Conexión macho-hembra con **abrazadera de unión sencilla**

NIVEL DE ESTANQUEIDAD

T--- N1: Sin necesidad de junta.

T200 - P1: con junta de estanqueidad (EW26Ø)*.

Para incluir la junta de estanqueidad (T<200°C) preinstalada de fábrica sustituir el código 671 por L08*. Excepto en terminales.

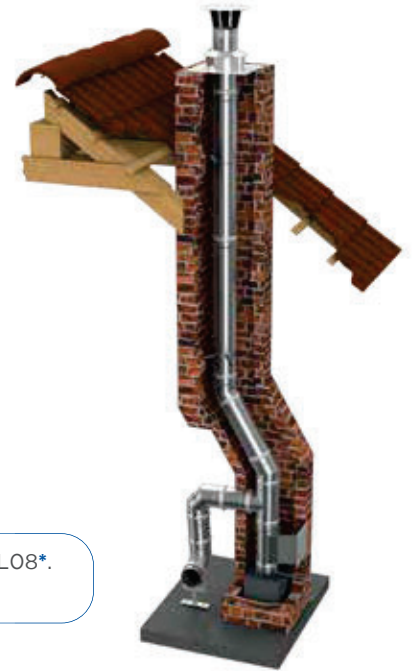

*con junta de estanqueidad

APLICACIONES

- Calderas y estufas de combustibles sólidos



CARACTERÍSTICAS

- Instalación por patinillo interior
- Temperatura de trabajo hasta 600°C
- Soldadura TIG/LÁSER** en continuo en todas las piezas
- Abrazadera de unión **NO INCLUIDA**
- Posibilidad de **corte de módulos rectos a medida en obra**

CERTIFICADO CE

0036 CPR 9174 029

CLASIFICACIONES CE (UNE-EN 1856-1)

T600 - N1 - D - V2 - L50040 - G(100)

T400 - N1 - W - V2 - L50040 - O(50)

T200 - P1 - W - V2 - L50040 - O(00) (con junta de estanqueidad T<200°C)



Precio unidad. u./c= unidad caja.



Módulo recto 1000mm

Módulo recto 500mm

Módulo recto 250mm

Módulo recto regulable
400-560mm

Módulo recto regulable
560-920mm

Ø80	671-EWEC130080	41.48€	Ø80	671-EWEC140080	29.13€	Ø80	671-EWEC150080	21.47€	Ø80	671-EWEC5440080	69€	Ø80	671-EWEC5450080	82€
Ø100	671-EWEC130100	48.89€	Ø100	671-EWEC140100	30.65€	Ø100	671-EWEC150100	23€	Ø100	671-EWEC5440100	77€	Ø100	671-EWEC5450100	91€
Ø130	671-EWEC130130	67€	Ø130	671-EWEC140130	36.8€	Ø130	671-EWEC150130	26.08€	Ø130	671-EWEC5440130	84€	Ø130	671-EWEC5450130	101€
Ø150	671-EWEC130150	74€	Ø150	671-EWEC140150	39.98€	Ø150	671-EWEC150150	27.59€	Ø150	671-EWEC5440150	104€	Ø150	671-EWEC5450150	125€
Ø180	671-EWEC130180	85€	Ø180	671-EWEC140180	44.43€	Ø180	671-EWEC150180	29.13€	Ø180	671-EWEC5440180	124€	Ø180	671-EWEC5450180	148€
Ø200	671-EWEC130200	94€	Ø200	671-EWEC140200	52€	Ø200	671-EWEC150200	30.65€	Ø200	671-EWEC5440200	143€	Ø200	671-EWEC5450200	173€
Ø250	671-EWEC130250	124€	Ø250	671-EWEC140250	67€	Ø250	671-EWEC150250	35.28€	Ø250	671-EWEC5440250	175€	Ø250	671-EWEC5450250	209€
Ø300	671-EWEC130300	148€	Ø300	671-EWEC140300	79€	Ø300	671-EWEC150300	41.48€	Ø300	671-EWEC5440300	208€	Ø300	671-EWEC5450300	253€
Ø350	671-EWEC130350	199€	Ø350	671-EWEC140350	101€	Ø350	671-EWEC150350	47.4€	Ø350	671-EWEC5440350	230€	Ø350	671-EWEC5450350	277€
Ø400	671-EWEC130400	225€	Ø400	671-EWEC140400	111€	Ø400	671-EWEC150400	50€	Ø400	671-EWEC5440400	252€	Ø400	671-EWEC5450400	305€
Ø450	671-EWEC130450	274€	Ø450	671-EWEC140450	151€	Ø450	671-EWEC150450	80€	Ø450	671-EWEC5440450	308€	Ø450	671-EWEC5450450	338€
Ø500	671-EWEC130500	324€	Ø500	671-EWEC140500	200€	Ø500	671-EWEC150500	119€	Ø500	671-EWEC5440500	337€	Ø500	671-EWEC5450500	377€
Ø550	671-EWEC130550	374€	Ø550	671-EWEC140550	233€	Ø550	671-EWEC150550	143€	Ø550	671-EWEC5440550	365€	Ø550	671-EWEC5450550	421€
Ø600	671-EWEC130600	404€	Ø600	671-EWEC140600	242€	Ø600	671-EWEC150600	144€	Ø600	671-EWEC5440600	393€	Ø600	671-EWEC5450600	460€
Ø650	671-EWEC130650	427€	Ø650	671-EWEC140650	253€	Ø650	671-EWEC150650	146€	Ø650	671-EWEC5440650	414€	Ø650	671-EWEC5450650	482€
Ø700	671-EWEC130700	533€	Ø700	671-EWEC140700	316€	Ø700	671-EWEC150700	180€	Ø700	671-EWEC5440700	518€	Ø700	671-EWEC5450700	603€
Ø750	671-EWEC130750	556€	Ø750	671-EWEC140750	331€	Ø750	671-EWEC150750	190€	Ø750	671-EWEC5440750	537€	Ø750	671-EWEC5450750	628€
Ø800	671-EWEC130800	603€	Ø800	671-EWEC140800	358€	Ø800	671-EWEC150800	207€	Ø800	671-EWEC5440800	585€	Ø800	671-EWEC5450800	687€



Módulo de descenso



Codo 15°



Codo 30°



Codo 45°



Codo 60°

Ø80	671-EWEC14680080	67€	Ø80	671-EWEC160080	21.47€	Ø80	671-EWEC170080	21.47€	Ø80	671-EWEC180080	21.47€	Ø80	671-EWEC840080	29.13€
Ø100	671-EWEC14680100	80€	Ø100	671-EWEC160100	23€	Ø100	671-EWEC170100	23€	Ø100	671-EWEC180100	23€	Ø100	671-EWEC840100	30.65€
Ø130	671-EWEC14680130	105€	Ø130	671-EWEC160130	27.59€	Ø130	671-EWEC170130	27.59€	Ø130	671-EWEC180130	27.59€	Ø130	671-EWEC840130	35.28€
Ø150	671-EWEC14680150	116€	Ø150	671-EWEC160150	35.28€	Ø150	671-EWEC170150	35.28€	Ø150	671-EWEC180150	35.28€	Ø150	671-EWEC840150	42.96€
Ø180	671-EWEC14680180	138€	Ø180	671-EWEC160180	42.96€	Ø180	671-EWEC170180	42.96€	Ø180	671-EWEC180180	42.96€	Ø180	671-EWEC840180	50€
Ø200	671-EWEC14680200	156€	Ø200	671-EWEC160200	48.89€	Ø200	671-EWEC170200	48.89€	Ø200	671-EWEC180200	48.89€	Ø200	671-EWEC840200	62€
Ø250	671-EWEC14680250	203€	Ø250	671-EWEC160250	58€	Ø250	671-EWEC170250	58€	Ø250	671-EWEC180250	58€	Ø250	671-EWEC840250	77€
Ø300	671-EWEC14680300	242€	Ø300	671-EWEC160300	84€	Ø300	671-EWEC170300	84€	Ø300	671-EWEC180300	84€	Ø300	671-EWEC840300	103€
Ø350	671-EWEC14680350	324€	Ø350	671-EWEC160350	116€	Ø350	671-EWEC170350	116€	Ø350	671-EWEC180350	116€	Ø350	671-EWEC840350	135€
Ø400	671-EWEC14680400	367€	Ø400	671-EWEC160400	142€	Ø400	671-EWEC170400	142€	Ø400	671-EWEC180400	142€	Ø400	671-EWEC840400	158€
Ø450	671-EWEC14680450	445€	Ø450	671-EWEC160450	208€	Ø450	671-EWEC170450	208€	Ø450	671-EWEC180450	208€	Ø450	671-EWEC840450	235€
Ø500	671-EWEC14680500	533€	Ø500	671-EWEC160500	238€	Ø500	671-EWEC170500	238€	Ø500	671-EWEC180500	238€	Ø500	671-EWEC840500	264€
Ø550	671-EWEC14680550	611€	Ø550	671-EWEC160550	279€	Ø550	671-EWEC170550	279€	Ø550	671-EWEC180550	279€	Ø550	671-EWEC840550	293€
Ø600	671-EWEC14680600	661€	Ø600	671-EWEC160600	301€	Ø600	671-EWEC170600	301€	Ø600	671-EWEC180600	301€	Ø600	671-EWEC840600	316€
Ø650	671-EWEC14680650	698€	Ø650	671-EWEC160650	314€	Ø650	671-EWEC170650	314€	Ø650	671-EWEC180650	314€	Ø650	-	-
Ø700	671-EWEC14680700	870€	Ø700	671-EWEC160700	392€	Ø700	671-EWEC170700	392€	Ø700	671-EWEC180700	392€	Ø700	-	-
Ø750	671-EWEC14680750	909€	Ø750	671-EWEC160750	405€	Ø750	671-EWEC170750	405€	Ø750	671-EWEC180750	405€	Ø750	-	-
Ø800	671-EWEC14680800	991€	Ø800	671-EWEC160800	444€	Ø800	671-EWEC170800	444€	Ø800	671-EWEC180800	444€	Ø800	-	-



CHIMENEA INDIVIDUAL

Sistema EW - ECO 316



Codo 90°



Codo 0°-90°
Multidireccional



Te 90°



Te 135°



Colector de hollín

Ø80	671-EWEC600080	30.65€	Ø80	671-EWEC1010080	69€	Ø80	671-EWEC3170080	63€	Ø80	671-EWEC120080	77€	Ø80	671-EWEC5510080	29.13€
Ø100	671-EWEC600100	35.28€	Ø100	671-EWEC1010100	69€	Ø100	671-EWEC3170100	74€	Ø100	671-EWEC120100	84€	Ø100	671-EWEC5510100	30.65€
Ø130	671-EWEC600130	39.98€	Ø130	671-EWEC1010130	80€	Ø130	671-EWEC3170130	85€	Ø130	671-EWEC120130	90€	Ø130	671-EWEC5510130	36.8€
Ø150	671-EWEC600150	47.4€	Ø150	671-EWEC1010150	94€	Ø150	671-EWEC3170150	103€	Ø150	671-EWEC120150	113€	Ø150	671-EWEC5510150	39.98€
Ø180	671-EWEC600180	58€	Ø180	671-EWEC1010180	114€	Ø180	671-EWEC3170180	105€	Ø180	671-EWEC120180	132€	Ø180	671-EWEC5510180	45.92€
Ø200	671-EWEC600200	70€	Ø200	671-EWEC1010200	131€	Ø200	671-EWEC3170200	133€	Ø200	671-EWEC120200	151€	Ø200	671-EWEC5510200	48.89€
Ø250	671-EWEC600250	89€	Ø250	671-EWEC1010250	158€	Ø250	671-EWEC3170250	158€	Ø250	671-EWEC120250	188€	Ø250	671-EWEC5510250	58€
Ø300	671-EWEC600300	114€	Ø300	-	-	Ø300	671-EWEC3170300	187€	Ø300	671-EWEC120300	237€	Ø300	671-EWEC5510300	74€
Ø350	671-EWEC600350	151€	Ø350	-	-	Ø350	671-EWEC3170350	222€	Ø350	671-EWEC120350	259€	Ø350	671-EWEC5510350	89€
Ø400	671-EWEC600400	175€	Ø400	-	-	Ø400	671-EWEC3170400	255€	Ø400	671-EWEC120400	286€	Ø400	671-EWEC5510400	115€
Ø450	671-EWEC600450	256€	Ø450	-	-	Ø450	671-EWEC3170450	400€	Ø450	671-EWEC120450	444€	Ø450	671-EWEC5510450	158€
Ø500	671-EWEC600500	288€	Ø500	-	-	Ø500	671-EWEC3170500	486€	Ø500	671-EWEC120500	518€	Ø500	671-EWEC5510500	170€
Ø550	671-EWEC600550	318€	Ø550	-	-	Ø550	671-EWEC3170550	615€	Ø550	671-EWEC120550	646€	Ø550	671-EWEC5510550	230€
Ø600	671-EWEC600600	348€	Ø600	-	-	Ø600	671-EWEC3170600	696€	Ø600	671-EWEC120600	1495€	Ø600	671-EWEC5510600	238€
Ø650	-	-	Ø650	-	-	Ø650	671-EWEC3170650	735€	Ø650	671-EWEC120650	1580€	Ø650	671-EWEC5510650	251€
Ø700	-	-	Ø700	-	-	Ø700	671-EWEC3170700	912€	Ø700	671-EWEC120700	1966€	Ø700	671-EWEC5510700	314€
Ø750	-	-	Ø750	-	-	Ø750	671-EWEC3170750	954€	Ø750	671-EWEC120750	2056€	Ø750	671-EWEC5510750	323€
Ø800	-	-	Ø800	-	-	Ø800	671-EWEC3170800	1039€	Ø800	671-EWEC120800	2239€	Ø800	671-EWEC5510800	353€



Colector de hollín con
desagüe



Codo 90° con tapa de
inspección P1



Módulo de inspección



Módulo de inspección con
tapa 200 Pa (P1)



Módulo de inspección con
tapa 40 Pa (N1)

Ø80	671-EWEC440080	36.8€	Ø80	671-EWEC19AL0080	93€	Ø80	671-EWEC5430080	38.52€	Ø80	671-EWEC5490080	134€	Ø80	671-EWEC680080	79€
Ø100	671-EWEC440100	39.98€	Ø100	671-EWEC19AL0100	113€	Ø100	671-EWEC5430100	42.96€	Ø100	671-EWEC5490100	146€	Ø100	671-EWEC680100	84€
Ø130	671-EWEC440130	44.43€	Ø130	671-EWEC19AL0130	121€	Ø130	671-EWEC5430130	45.92€	Ø130	671-EWEC5490130	156€	Ø130	671-EWEC680130	94€
Ø150	671-EWEC440150	45.92€	Ø150	671-EWEC19AL0150	153€	Ø150	671-EWEC5430150	58€	Ø150	671-EWEC5490150	160€	Ø150	671-EWEC680150	116€
Ø180	671-EWEC440180	47.4€	Ø180	671-EWEC19AL0180	188€	Ø180	671-EWEC5430180	70€	Ø180	671-EWEC5490180	169€	Ø180	671-EWEC680180	143€
Ø200	671-EWEC440200	48.89€	Ø200	671-EWEC19AL0200	231€	Ø200	671-EWEC5430200	79€	Ø200	671-EWEC5490200	177€	Ø200	671-EWEC680200	160€
Ø250	671-EWEC440250	69€	Ø250	671-EWEC19AL0250	273€	Ø250	671-EWEC5430250	94€	Ø250	671-EWEC5490250	209€	Ø250	671-EWEC680250	199€
Ø300	671-EWEC440300	82€	Ø300	671-EWEC19AL0300	304€	Ø300	671-EWEC5430300	114€	Ø300	671-EWEC5490300	228€	Ø300	671-EWEC680300	237€
Ø350	671-EWEC440350	101€	Ø350	671-EWEC19AL0350	364€	Ø350	671-EWEC5430350	124€	Ø350	671-EWEC5490350	264€	Ø350	671-EWEC680350	258€
Ø400	671-EWEC440400	176€	Ø400	671-EWEC19AL0400	432€	Ø400	671-EWEC5430400	135€	Ø400	671-EWEC5490400	377€	Ø400	671-EWEC680400	286€
Ø450	671-EWEC440450	225€	Ø450	671-EWEC19AL0450	662€	Ø450	671-EWEC5430450	194€	Ø450	671-EWEC5490450	407€	Ø450	671-EWEC680450	403€
Ø500	671-EWEC440500	255€	Ø500	671-EWEC19AL0500	756€	Ø500	671-EWEC5430500	230€	Ø500	671-EWEC5490500	414€	Ø500	671-EWEC680500	530€
Ø550	671-EWEC440550	277€	Ø550	671-EWEC19AL0550	916€	Ø550	671-EWEC5430550	242€	Ø550	671-EWEC5490550	434€	Ø550	671-EWEC680550	687€
Ø600	671-EWEC440600	281€	Ø600	671-EWEC19AL0600	1091€	Ø600	671-EWEC5430600	256€	Ø600	671-EWEC5490600	501€	Ø600	671-EWEC680600	742€
Ø650	671-EWEC440650	298€	Ø650	-	-	Ø650	671-EWEC5430650	271€	Ø650	671-EWEC5490650	512€	Ø650	671-EWEC680650	782€
Ø700	671-EWEC440700	369€	Ø700	-	-	Ø700	671-EWEC5430700	338€	Ø700	671-EWEC5490700	518€	Ø700	671-EWEC680700	972€
Ø750	671-EWEC440750	386€	Ø750	-	-	Ø750	671-EWEC5430750	348€	Ø750	671-EWEC5490750	537€	Ø750	671-EWEC680750	1017€
Ø800	671-EWEC440800	423€	Ø800	-	-	Ø800	671-EWEC5430800	384€	Ø800	671-EWEC5490800	585€	Ø800	671-EWEC680800	1105€



En los diámetros Ø80 y Ø100 las lamas sobresalen del diámetro del tubo.



Para ángulos diferentes de 90° se produce un cierto desplazamiento del eje.



Módulo temperatura humos



Terminal salida libre



Terminal anti-lluvia



Terminal anti-viento



Terminal horizontal con rejilla

Ø80	671-EWEC870080	214€	Ø80	671-EWEC320080	54€	Ø80	671-EWEC5260080	76€	Ø80	671-EWEC5270080	113€	Ø80	671-EWEC5320080	62€
Ø100	671-EWEC870100	221€	Ø100	671-EWEC320100	61€	Ø100	671-EWEC5260100	84€	Ø100	671-EWEC5270100	124€	Ø100	671-EWEC5320100	69€
Ø130	671-EWEC870130	267€	Ø130	671-EWEC320130	69€	Ø130	671-EWEC5260130	93€	Ø130	671-EWEC5270130	135€	Ø130	671-EWEC5320130	77€
Ø150	671-EWEC870150	331€	Ø150	671-EWEC320150	84€	Ø150	671-EWEC5260150	116€	Ø150	671-EWEC5270150	173€	Ø150	671-EWEC5320150	93€
Ø180	671-EWEC870180	393€	Ø180	671-EWEC320180	101€	Ø180	671-EWEC5260180	142€	Ø180	671-EWEC5270180	200€	Ø180	671-EWEC5320180	114€
Ø200	671-EWEC870200	451€	Ø200	671-EWEC320200	114€	Ø200	671-EWEC5260200	160€	Ø200	671-EWEC5270200	233€	Ø200	671-EWEC5320200	130€
Ø250	671-EWEC870250	564€	Ø250	671-EWEC320250	142€	Ø250	671-EWEC5260250	198€	Ø250	671-EWEC5270250	286€	Ø250	671-EWEC5320250	158€
Ø300	671-EWEC870300	676€	Ø300	671-EWEC320300	168€	Ø300	671-EWEC5260300	236€	Ø300	671-EWEC5270300	343€	Ø300	671-EWEC5320300	190€
Ø350	671-EWEC870350	744€	Ø350	671-EWEC320350	184€	Ø350	671-EWEC5260350	258€	Ø350	671-EWEC5270350	401€	Ø350	671-EWEC5320350	207€
Ø400	671-EWEC870400	819€	Ø400	671-EWEC320400	203€	Ø400	671-EWEC5260400	285€	Ø400	671-EWEC5270400	502€	Ø400	671-EWEC5320400	228€
Ø450	671-EWEC870450	893€	Ø450	671-EWEC320450	253€	Ø450	-	-	Ø450	-	-	Ø450	671-EWEC5320450	285€
Ø500	671-EWEC870500	969€	Ø500	671-EWEC320500	273€	Ø500	-	-	Ø500	-	-	Ø500	671-EWEC5320500	308€
Ø550	671-EWEC870550	1056€	Ø550	671-EWEC320550	347€	Ø550	-	-	Ø550	-	-	Ø550	671-EWEC5320550	393€
Ø600	671-EWEC870600	1143€	Ø600	671-EWEC320600	375€	Ø600	-	-	Ø600	-	-	Ø600	671-EWEC5320600	426€
Ø650	671-EWEC870650	1208€	Ø650	671-EWEC320650	393€	Ø650	-	-	Ø650	-	-	Ø650	671-EWEC5320650	445€
Ø700	671-EWEC870700	1501€	Ø700	671-EWEC320700	491€	Ø700	-	-	Ø700	-	-	Ø700	671-EWEC5320700	557€
Ø750	671-EWEC870750	1569€	Ø750	671-EWEC320750	511€	Ø750	-	-	Ø750	-	-	Ø750	671-EWEC5320750	581€
Ø800	671-EWEC870800	1714€	Ø800	671-EWEC320800	558€	Ø800	-	-	Ø800	-	-	Ø800	671-EWEC5320800	629€



Terminal Gas



Terminal GAS light



Regulador de tiro



Estabilizador de tiro (adaptador + clapeta)



Adaptador a Hurricane

Ø80	-	-	Ø80	671-EWEC4350080	207€	Ø80	671-EWEC5310080	132€	Ø80	671-EWEC9700080	179€	Ø80	-	-
Ø100	-	-	Ø100	671-EWEC43500100	221€	Ø100	671-EWEC5310100	131€	Ø100	671-EWEC9700100	188€	Ø100	-	-
Ø130	671-EWEC14540130	318€	Ø130	671-EWEC43500130	238€	Ø130	671-EWEC5310130	131€	Ø130	671-EWEC9700130	192€	Ø130	671-EWEC44760130	83€
Ø150	671-EWEC14540150	356€	Ø150	671-EWEC43500150	278€	Ø150	671-EWEC5310150	151€	Ø150	671-EWEC9700150	221€	Ø150	671-EWEC44760150	83€
Ø180	671-EWEC14540180	393€	Ø180	671-EWEC43500180	304€	Ø180	671-EWEC5310180	174€	Ø180	671-EWEC9700180	230€	Ø180	671-EWEC44760180	93€
Ø200	671-EWEC14540200	497€	Ø200	671-EWEC43500200	338€	Ø200	671-EWEC5310200	199€	Ø200	671-EWEC9700200	255€	Ø200	671-EWEC44760200	121€
Ø250	671-EWEC14540250	605€	Ø250	671-EWEC43500250	446€	Ø250	671-EWEC5310250	283€	Ø250	671-EWEC9700250	274€	Ø250	671-EWEC44760250	142€
Ø300	671-EWEC14540300	690€	Ø300	671-EWEC43500300	581€	Ø300	671-EWEC5310300	383€	Ø300	671-EWEC9700300	316€	Ø300	671-EWEC44760300	180€
Ø350	671-EWEC14540350	908€	Ø350	-	-	Ø350	671-EWEC5310350	436€	Ø350	671-EWEC9700350	340€	Ø350	-	-
Ø400	671-EWEC14540400	1011€	Ø400	-	-	Ø400	671-EWEC5310400	564€	Ø400	671-EWEC9700400	348€	Ø400	-	-
Ø450	671-EWEC14540450	1225€	Ø450	-	-	Ø450	671-EWEC5310450	658€	Ø450	671-EWEC9700450	368€	Ø450	-	-
Ø500	671-EWEC14540500	1556€	Ø500	-	-	Ø500	671-EWEC5310500	760€	Ø500	671-EWEC9700500	386€	Ø500	-	-
Ø550	671-EWEC14540550	1746€	Ø550	-	-	Ø550	671-EWEC5310550	782€	Ø550	671-EWEC9700550	389€	Ø550	-	-
Ø600	671-EWEC14540600	1926€	Ø600	-	-	Ø600	671-EWEC5310600	755€	Ø600	671-EWEC9700600	413€	Ø600	-	-
Ø650	671-EWEC14540650	2040€	Ø650	-	-	Ø650	671-EWEC5310650	883€	Ø650	671-EWEC9700650	432€	Ø650	-	-
Ø700	671-EWEC14540700	2537€	Ø700	-	-	Ø700	671-EWEC5310700	1086€	Ø700	671-EWEC9700700	539€	Ø700	-	-
Ø750	671-EWEC14540750	2651€	Ø750	-	-	Ø750	671-EWEC5310750	1254€	Ø750	671-EWEC9700750	563€	Ø750	-	-
Ø800	671-EWEC14540800	2890€	Ø800	-	-	Ø800	671-EWEC5310800	1531€	Ø800	671-EWEC9700800	616€	Ø800	-	-



CHIMENEA INDIVIDUAL

Sistema EW - ECO 316



Manguito hembra-hembra



Manguito macho-macho



Soporte de carga regulable



Abrazadera de unión 1.0



Abrazadera fijación pared regulable 50-80mm

Ø80	671-EWEC6130080	13.81€	Ø80	671-EWEC9720080	13.81€	Ø80	671-EWEC3790080	63€	Ø80	665-ZUWA450080	6.15€	Ø80	665-ZUWA5560080	29.13€
Ø100	671-EWEC6130100	21.47€	Ø100	671-EWEC9720100	21.47€	Ø100	671-EWEC3790100	72€	Ø100	665-ZUWA450100	6.15€	Ø100	665-ZUWA5560100	32.19€
Ø130	671-EWEC6130130	26.08€	Ø130	671-EWEC9720130	27.59€	Ø130	671-EWEC3790130	79€	Ø130	665-ZUWA450130	6.15€	Ø130	665-ZUWA5560130	35.28€
Ø150	671-EWEC6130150	30.65€	Ø150	671-EWEC9720150	30.65€	Ø150	671-EWEC3790150	94€	Ø150	665-ZUWA450150	7.68€	Ø150	665-ZUWA5560150	36.8€
Ø180	671-EWEC6130180	39.98€	Ø180	671-EWEC9720180	39.98€	Ø180	671-EWEC3790180	116€	Ø180	665-ZUWA450180	9.19€	Ø180	665-ZUWA5560180	36.8€
Ø200	671-EWEC6130200	41.48€	Ø200	671-EWEC9720200	41.48€	Ø200	671-EWEC3790200	131€	Ø200	665-ZUWA450200	10.73€	Ø200	665-ZUWA5560200	42.96€
Ø250	671-EWEC6130250	45.92€	Ø250	671-EWEC9720250	45.92€	Ø250	671-EWEC3790250	162€	Ø250	665-ZUWA450250	19.94€	Ø250	665-ZUWA5560250	57€
Ø300	671-EWEC6130300	50€	Ø300	671-EWEC9720300	50€	Ø300	671-EWEC3790300	194€	Ø300	665-ZUWA450300	24.54€	Ø300	665-ZUWA5560300	60€
Ø350	671-EWEC6130350	62€	Ø350	671-EWEC9720350	62€	Ø350	671-EWEC3790350	210€	Ø350	665-ZUWA450350	27.59€	Ø350	665-ZUWA5560350	63€
Ø400	671-EWEC6130400	84€	Ø400	671-EWEC9720400	84€	Ø400	671-EWEC3790400	233€	Ø400	665-ZUWA450400	35.28€	Ø400	665-ZUWA5560400	83€
Ø450	671-EWEC6130450	95€	Ø450	671-EWEC9720450	95€	Ø450	671-EWEC3790450	343€	Ø450	665-ZUWA450450	39.98€	Ø450	665-ZUWA5560450	92€
Ø500	671-EWEC6130500	121€	Ø500	671-EWEC9720500	121€	Ø500	671-EWEC3790500	481€	Ø500	665-ZUWA450500	44.43€	Ø500	-	-
Ø550	671-EWEC6130550	194€	Ø550	671-EWEC9720550	194€	Ø550	671-EWEC3790550	701€	Ø550	665-ZUWA450550	47.4€	Ø550	-	-
Ø600	671-EWEC6130600	222€	Ø600	671-EWEC9720600	222€	Ø600	671-EWEC3790600	757€	Ø600	665-ZUWA450600	55€	Ø600	-	-
Ø650	671-EWEC6130650	231€	Ø650	671-EWEC9720650	231€	Ø650	671-EWEC3790650	800€	Ø650	665-ZUWA450650	60€	Ø650	-	-
Ø700	671-EWEC6130700	287€	Ø700	671-EWEC9720700	287€	Ø700	671-EWEC3790700	994€	Ø700	665-ZUWA450700	73€	Ø700	-	-
Ø750	671-EWEC6130750	301€	Ø750	671-EWEC9720750	301€	Ø750	671-EWEC3790750	1039€	Ø750	665-ZUWA450750	89€	Ø750	-	-
Ø800	671-EWEC6130800	324€	Ø800	671-EWEC9720800	324€	Ø800	671-EWEC3790800	1132€	Ø800	665-ZUWA450800	98€	Ø800	-	-



Abrazadera fijación pared fija



Abrazadera fijación pared sencilla



Base de abrazadera distanciadora



Alas distanciadoras A



Alas distanciadoras B

Ø80	-	-	Ø80	665-ZUWA5350080	10.73€	Ø80	665-ZUWA14620080	36.8€	Ø80	665-ZUWA1462A	44.43€	Ø80	665-ZUWA1462B	61€
Ø100	-	-	Ø100	665-ZUWA5350100	13.81€	Ø100	665-ZUWA14620100	38.52€	Ø100			Ø100		
Ø130	-	-	Ø130	665-ZUWA5350130	13.81€	Ø130	665-ZUWA14620130	42.96€	Ø130			Ø130		
Ø150	-	-	Ø150	665-ZUWA5350150	18.39€	Ø150	665-ZUWA14620150	45.92€	Ø150			Ø150		
Ø180	-	-	Ø180	665-ZUWA5350180	24.54€	Ø180	665-ZUWA14620180	48.89€	Ø180			Ø180		
Ø200	-	-	Ø200	665-ZUWA5350200	27.59€	Ø200	665-ZUWA14620200	54€	Ø200			Ø200		
Ø250	-	-	Ø250	-	-	Ø250	665-ZUWA14620250	94€	Ø250			Ø250		
Ø300	-	-	Ø300	-	-	Ø300	665-ZUWA14620300	130€	Ø300			Ø300		
Ø350	-	-	Ø350	-	-	Ø350	665-ZUWA14620350	175€	Ø350			Ø350		
Ø400	-	-	Ø400	-	-	Ø400	665-ZUWA14620400	227€	Ø400			Ø400		
Ø450	-	-	Ø450	-	-	Ø450	665-ZUWA14620450	281€	Ø450			Ø450		
Ø500	665-ZUWA556F0500	116€	Ø500	-	-	Ø500	665-ZUWA14620500	309€	Ø500			Ø500		
Ø550	665-ZUWA556F0550	146€	Ø550	-	-	Ø550	665-ZUWA14620550	344€	Ø550			Ø550		
Ø600	665-ZUWA556F0600	175€	Ø600	-	-	Ø600	665-ZUWA14620600	388€	Ø600	Ø600				
Ø650	665-ZUWA556F0650	191€	Ø650	-	-	Ø650	665-ZUWA14620650	418€	Ø650	Ø650				
Ø700	665-ZUWA556F0700	249€	Ø700	-	-	Ø700	665-ZUWA14620700	539€	Ø700	Ø700				
Ø750	665-ZUWA556F0750	303€	Ø750	-	-	Ø750	665-ZUWA14620750	553€	Ø750	Ø750				
Ø800	665-ZUWA556F0800	338€	Ø800	-	-	Ø800	665-ZUWA14620800	741€	Ø800	Ø800				



Alas distanciadoras C



Alas distanciadoras D



Abrazadera de descenso



Abrazadera de araña



Abrazadera de soporte

Ø80	665-ZUWA1462C	77€	Ø80	665-ZUWA1462D	98€	Ø80	665-ZUWA40D0080	13.81€	Ø80	665-ZUWA400080	9.19€	Ø80	-	-
Ø100			Ø100			665-ZUWA40D0100	13.81€	Ø100	665-ZUWA400100	9.19€	Ø100	-	-	
Ø130			Ø130			665-ZUWA40D0130	13.81€	Ø130	665-ZUWA400130	9.19€	Ø130	-	-	
Ø150			Ø150			665-ZUWA40D0150	18.39€	Ø150	665-ZUWA400150	9.19€	Ø150	-	-	
Ø180			Ø180			665-ZUWA40D0180	23€	Ø180	665-ZUWA400180	13.81€	Ø180	665-ZUWA8580180	137€	
Ø200			Ø200			665-ZUWA40D0200	26.08€	Ø200	665-ZUWA400200	13.81€	Ø200	665-ZUWA8580200	137€	
Ø250			Ø250			665-ZUWA40D0250	38.52€	Ø250	665-ZUWA400250	24.54€	Ø250	665-ZUWA8580250	175€	
Ø300			Ø300			665-ZUWA40D0300	45.92€	Ø300	665-ZUWA400300	27.59€	Ø300	665-ZUWA8580300	191€	
Ø350			Ø350			665-ZUWA40D0350	52€	Ø350	665-ZUWA400350	32.19€	Ø350	665-ZUWA8580350	209€	
Ø400			Ø400			665-ZUWA40D0400	70€	Ø400	665-ZUWA400400	35.28€	Ø400	665-ZUWA8580400	254€	
Ø450			Ø450			665-ZUWA40D0450	80€	Ø450	665-ZUWA400450	38.52€	Ø450	665-ZUWA8580450	303€	
Ø500			Ø500			665-ZUWA40D0500	89€	Ø500	665-ZUWA400500	52€	Ø500	665-ZUWA8580500	334€	
Ø550			Ø550			665-ZUWA40D0550	93€	Ø550	665-ZUWA400550	70€	Ø550	665-ZUWA8580550	378€	
Ø600			Ø600			665-ZUWA40D0600	111€	Ø600	665-ZUWA400600	92€	Ø600	665-ZUWA8580600	428€	
Ø650			Ø650			665-ZUWA40D0650	116€	Ø650	665-ZUWA400650	100€	Ø650	665-ZUWA8580650	464€	
Ø700			Ø700			665-ZUWA40D0700	143€	Ø700	665-ZUWA400700	130€	Ø700	665-ZUWA8580700	600€	
Ø750			Ø750			665-ZUWA40D0750	175€	Ø750	665-ZUWA400750	156€	Ø750	665-ZUWA8580750	735€	
Ø800	Ø800	665-ZUWA40D0800	193€	Ø800	665-ZUWA400800	176€	Ø800	665-ZUWA8580800	820€					



Abrazadera con doble pértiga telescópica L=2000mm



Abrazadera forjado inox



Abrazadera para amarre por tornillo



Abrazadera vientos



Soporte de techo

Ø80	-	-	Ø80	665-ZUWA620080	16.87€	Ø80	665-ZUWA10630080	24.54€	Ø80	665-ZUWA420080	9.19€	Ø80	665-ZUWA9360080	27.59€
Ø100	-	-	Ø100	665-ZUWA620100	19.94€	Ø100	665-ZUWA10630100	27.59€	Ø100	665-ZUWA420100	9.19€	Ø100	665-ZUWA9360100	30.65€
Ø130	665-ZUWA1910130	136€	Ø130	665-ZUWA620130	24.54€	Ø130	665-ZUWA10630130	30.65€	Ø130	665-ZUWA420130	10.73€	Ø130	665-ZUWA9360130	32.19€
Ø150	665-ZUWA1910150	138€	Ø150	665-ZUWA620150	29.13€	Ø150	665-ZUWA10630150	33.72€	Ø150	665-ZUWA420150	13.81€	Ø150	665-ZUWA9360150	38.52€
Ø180	665-ZUWA1910180	147€	Ø180	665-ZUWA620180	39.98€	Ø180	665-ZUWA10630180	36.8€	Ø180	665-ZUWA420180	19.94€	Ø180	665-ZUWA9360180	47.4€
Ø200	665-ZUWA1910200	163€	Ø200	665-ZUWA620200	44.43€	Ø200	665-ZUWA10630200	39.98€	Ø200	665-ZUWA420200	24.54€	Ø200	665-ZUWA9360200	52€
Ø250	665-ZUWA1910250	184€	Ø250	665-ZUWA620250	47.4€	Ø250	665-ZUWA10630250	47.4€	Ø250	665-ZUWA420250	27.59€	Ø250	665-ZUWA9360250	69€
Ø300	665-ZUWA1910300	219€	Ø300	665-ZUWA620300	55€	Ø300	665-ZUWA10630300	61€	Ø300	665-ZUWA420300	32.19€	Ø300	665-ZUWA9360300	80€
Ø350	665-ZUWA1910350	235€	Ø350	665-ZUWA620350	62€	Ø350	665-ZUWA10630350	70€	Ø350	665-ZUWA420350	35.28€	Ø350	665-ZUWA9360350	89€
Ø400	665-ZUWA1910400	256€	Ø400	665-ZUWA620400	70€	Ø400	665-ZUWA10630400	80€	Ø400	665-ZUWA420400	38.52€	Ø400	665-ZUWA9360400	98€
Ø450	665-ZUWA1910450	358€	Ø450	665-ZUWA620450	79€	Ø450	665-ZUWA10630450	91€	Ø450	665-ZUWA420450	52€	Ø450	665-ZUWA9360450	136€
Ø500	665-ZUWA1910500	468€	Ø500	665-ZUWA620500	90€	Ø500	665-ZUWA10630500	100€	Ø500	665-ZUWA420500	70€	Ø500	665-ZUWA9360500	176€
Ø550	665-ZUWA1910550	610€	Ø550	665-ZUWA620550	97€	Ø550	665-ZUWA10630550	108€	Ø550	665-ZUWA420550	92€	Ø550	665-ZUWA9360550	227€
Ø600	665-ZUWA1910600	659€	Ø600	665-ZUWA620600	103€	Ø600	665-ZUWA10630600	121€	Ø600	665-ZUWA420600	100€	Ø600	665-ZUWA9360600	249€
Ø650	665-ZUWA1910650	722€	Ø650	665-ZUWA620650	109€	Ø650	665-ZUWA10630650	131€	Ø650	665-ZUWA420650	108€	Ø650	665-ZUWA9360650	270€
Ø700	665-ZUWA1910700	821€	Ø700	665-ZUWA620700	115€	Ø700	665-ZUWA10630700	143€	Ø700	665-ZUWA420700	143€	Ø700	665-ZUWA9360700	310€
Ø750	665-ZUWA1910750	920€	Ø750	665-ZUWA620750	122€	Ø750	665-ZUWA10630750	158€	Ø750	665-ZUWA420750	175€	Ø750	665-ZUWA9360750	346€
Ø800	665-ZUWA1910800	1062€	Ø800	665-ZUWA620800	128€	Ø800	665-ZUWA10630800	169€	Ø800	665-ZUWA420800	192€	Ø800	665-ZUWA9360800	397€



CHIMENEA INDIVIDUAL

Sistema EW - ECO 316

i Precio unidad. u/c= unidad caja.

i Necesario instalar collarín con el cubreaguas.



Collarín antitormenta



Cubreaguas 25°-45° aluminio



Cubreaguas 5°-25° aluminio



Cubreaguas plano inox



Cubreaguas plomo 0°-5°

Ø80	665-ZUWA3070080	24.54€	Ø80	665-ZUWA939AL0080	177€	Ø80	665-ZUWA938AL0080	174€	Ø80	665-ZUWA11280080	136€	Ø80	665-ZUWA9370080	191€
Ø100	665-ZUWA3070100	26.08€	Ø100	665-ZUWA939AL0100	190€	Ø100	665-ZUWA938AL0100	180€	Ø100	665-ZUWA11280100	137€	Ø100	665-ZUWA9370100	192€
Ø130	665-ZUWA3070130	27.59€	Ø130	665-ZUWA939AL0130	207€	Ø130	665-ZUWA938AL0130	194€	Ø130	665-ZUWA11280130	138€	Ø130	665-ZUWA9370130	193€
Ø150	665-ZUWA3070150	32.19€	Ø150	665-ZUWA939AL0150	219€	Ø150	665-ZUWA938AL0150	203€	Ø150	665-ZUWA11280150	142€	Ø150	665-ZUWA9370150	194€
Ø180	665-ZUWA3070180	38.52€	Ø180	665-ZUWA939AL0180	236€	Ø180	665-ZUWA938AL0180	221€	Ø180	665-ZUWA11280180	160€	Ø180	665-ZUWA9370180	220€
Ø200	665-ZUWA3070200	44.43€	Ø200	665-ZUWA939AL0200	253€	Ø200	665-ZUWA938AL0200	238€	Ø200	665-ZUWA11280200	175€	Ø200	665-ZUWA9370200	245€
Ø250	665-ZUWA3070250	55€	Ø250	665-ZUWA939AL0250	287€	Ø250	665-ZUWA938AL0250	266€	Ø250	665-ZUWA11280250	199€	Ø250	665-ZUWA9370250	277€
Ø300	665-ZUWA3070300	67€	Ø300	665-ZUWA939AL0300	313€	Ø300	665-ZUWA938AL0300	299€	Ø300	665-ZUWA11280300	219€	Ø300	665-ZUWA9370300	305€
Ø350	665-ZUWA3070350	73€	Ø350	665-ZUWA939AL0350	365€	Ø350	665-ZUWA938AL0350	331€	Ø350	665-ZUWA11280350	245€	Ø350	665-ZUWA9370350	340€
Ø400	665-ZUWA3070400	79€	Ø400	665-ZUWA939AL0400	408€	Ø400	665-ZUWA938AL0400	368€	Ø400	665-ZUWA11280400	270€	Ø400	665-ZUWA9370400	373€
Ø450	665-ZUWA3070450	108€	Ø450	665-ZUWA939AL0450	464€	Ø450	665-ZUWA938AL0450	411€	Ø450	665-ZUWA11280450	288€	Ø450	665-ZUWA9370450	404€
Ø500	665-ZUWA3070500	143€	Ø500	665-ZUWA939AL0500	517€	Ø500	665-ZUWA938AL0500	460€	Ø500	665-ZUWA11280500	332€	Ø500	665-ZUWA9370500	460€
Ø550	665-ZUWA3070550	187€	Ø550	665-ZUWA939AL0550	572€	Ø550	665-ZUWA938AL0550	494€	Ø550	665-ZUWA11280550	367€	Ø550	665-ZUWA9370550	508€
Ø600	665-ZUWA3070600	199€	Ø600	665-ZUWA939AL0600	623€	Ø600	665-ZUWA938AL0600	540€	Ø600	665-ZUWA11280600	412€	Ø600	665-ZUWA9370600	571€
Ø650	665-ZUWA3070650	220€	Ø650	665-ZUWA939AL0650	688€	Ø650	665-ZUWA938AL0650	583€	Ø650	665-ZUWA11280650	464€	Ø650	665-ZUWA9370650	645€
Ø700	665-ZUWA3070700	252€	Ø700	665-ZUWA939AL0700	792€	Ø700	665-ZUWA938AL0700	640€	Ø700	665-ZUWA11280700	519€	Ø700	665-ZUWA9370700	719€
Ø750	665-ZUWA3070750	279€	Ø750	665-ZUWA939AL0750	885€	Ø750	665-ZUWA938AL0750	694€	Ø750	665-ZUWA11280750	553€	Ø750	665-ZUWA9370750	768€
Ø800	665-ZUWA3070800	323€	Ø800	665-ZUWA939AL0800	1058€	Ø800	665-ZUWA938AL0800	829€	Ø800	665-ZUWA11280800	579€	Ø800	665-ZUWA9370800	801€

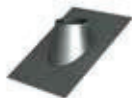

Cubreaguas plomo 25°-45°

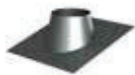

Cubreaguas plomo 5°-25°



Pasamuros



Junta de silicona
(T<200°C)

Ø80	665-ZUWA9390080	328€	Ø80	665-ZUWA9380080	191€	Ø80	665-ZUWA9870080	29.13€	Ø80	665-ZUWA260080	4.6€
Ø100	665-ZUWA9390100	336€	Ø100	665-ZUWA9380100	192€	Ø100	665-ZUWA9870100	35.28€	Ø100	665-ZUWA260100	4.6€
Ø130	665-ZUWA9390130	338€	Ø130	665-ZUWA9380130	193€	Ø130	665-ZUWA9870130	36.8€	Ø130	665-ZUWA260130	4.6€
Ø150	665-ZUWA9390150	342€	Ø150	665-ZUWA9380150	194€	Ø150	665-ZUWA9870150	38.52€	Ø150	665-ZUWA260150	4.6€
Ø180	665-ZUWA9390180	357€	Ø180	665-ZUWA9380180	220€	Ø180	665-ZUWA9870180	48.89€	Ø180	665-ZUWA260180	6.15€
Ø200	665-ZUWA9390200	364€	Ø200	665-ZUWA9380200	245€	Ø200	665-ZUWA9870200	48.89€	Ø200	665-ZUWA260200	7.68€
Ø250	665-ZUWA9390250	378€	Ø250	665-ZUWA9380250	277€	Ø250	665-ZUWA9870250	61€	Ø250	665-ZUWA260250	10.73€
Ø300	665-ZUWA9390300	393€	Ø300	665-ZUWA9380300	305€	Ø300	665-ZUWA9870300	79€	Ø300	665-ZUWA260300	13.81€
Ø350	665-ZUWA9390350	406€	Ø350	665-ZUWA9380350	340€	Ø350	665-ZUWA9870350	89€	Ø350	665-ZUWA260350	16.87€
Ø400	665-ZUWA9390400	428€	Ø400	665-ZUWA9380400	373€	Ø400	665-ZUWA9870400	114€	Ø400	665-ZUWA260400	18.39€
Ø450	665-ZUWA9390450	510€	Ø450	665-ZUWA9380450	404€	Ø450	665-ZUWA9870450	147€	Ø450	665-ZUWA260450	19.94€
Ø500	665-ZUWA9390500	583€	Ø500	665-ZUWA9380500	460€	Ø500	665-ZUWA9870500	192€	Ø500	665-ZUWA260500	23€
Ø550	665-ZUWA9390550	651€	Ø550	665-ZUWA9380550	508€	Ø550	665-ZUWA9870550	209€	Ø550	665-ZUWA260550	26.08€
Ø600	665-ZUWA9390600	730€	Ø600	665-ZUWA9380600	571€	Ø600	665-ZUWA9870600	230€	Ø600	665-ZUWA260600	29.13€
Ø650	665-ZUWA9390650	819€	Ø650	665-ZUWA9380650	645€	Ø650	665-ZUWA9870650	255€	Ø650	665-ZUWA260650	33.72€
Ø700	665-ZUWA9390700	916€	Ø700	665-ZUWA9380700	719€	Ø700	665-ZUWA9870700	317€	Ø700	665-ZUWA260700	38.52€
Ø750	665-ZUWA9390750	975€	Ø750	665-ZUWA9380750	768€	Ø750	665-ZUWA9870750	375€	Ø750	665-ZUWA260750	42.96€
Ø800	665-ZUWA9390800	1019€	Ø800	665-ZUWA9380800	801€	Ø800	665-ZUWA9870800	439€	Ø800	665-ZUWA260800	45.92€

ADAPTADOR CALDERA HEMBRA

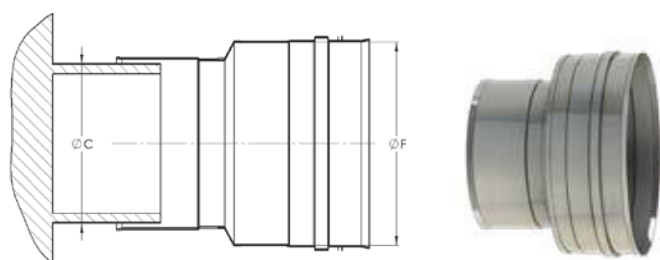

CÓDIGO	Ø A	Ø B	€
671-EWEC37H00800080	Ø80	Ø80	26.08€
671-EWEC37H00800100	Ø80	Ø100	62€
671-EWEC37H00800130	Ø80	Ø130	63€
671-EWEC37H01000080	Ø100	Ø80	63€
671-EWEC37H01000100	Ø100	Ø100	27.59€
671-EWEC37H01000130	Ø100	Ø130	67€
671-EWEC37H01000150	Ø100	Ø150	77€
671-EWEC37H01100080	Ø110	Ø80	63€
671-EWEC37H01100100	Ø110	Ø100	67€
671-EWEC37H01100130	Ø110	Ø130	67€
671-EWEC37H01100150	Ø110	Ø150	77€
671-EWEC37H01200080	Ø120	Ø80	67€
671-EWEC37H01200100	Ø120	Ø100	67€
671-EWEC37H01200130	Ø120	Ø130	67€
671-EWEC37H01200150	Ø120	Ø150	77€
671-EWEC37H01250080	Ø125	Ø80	67€
671-EWEC37H01250100	Ø125	Ø100	67€
671-EWEC37H01250130	Ø125	Ø130	30.65€
671-EWEC37H01250150	Ø125	Ø150	77€
671-EWEC37H01300080	Ø130	Ø80	67€
671-EWEC37H01300100	Ø130	Ø100	67€
671-EWEC37H01300130	Ø130	Ø130	30.65€
671-EWEC37H01300150	Ø130	Ø150	79€
671-EWEC37H01300180	Ø130	Ø180	92€
671-EWEC37H01350080	Ø135	Ø80	61€
671-EWEC37H01350100	Ø135	Ø100	80€
671-EWEC37H01350130	Ø135	Ø130	30.65€
671-EWEC37H01350150	Ø135	Ø150	79€
671-EWEC37H01350180	Ø135	Ø180	92€
671-EWEC37H01400080	Ø140	Ø80	100€
671-EWEC37H01400100	Ø140	Ø100	80€
671-EWEC37H01400130	Ø140	Ø130	82€
671-EWEC37H01400150	Ø140	Ø150	36.8€
671-EWEC37H01400180	Ø140	Ø180	92€
671-EWEC37H01500080	Ø150	Ø80	101€
671-EWEC37H01500100	Ø150	Ø100	80€
671-EWEC37H01500130	Ø150	Ø130	82€
671-EWEC37H01500150	Ø150	Ø150	36.8€
671-EWEC37H01500180	Ø150	Ø180	92€
671-EWEC37H01500200	Ø150	Ø200	105€
671-EWEC37H01600080	Ø160	Ø80	167€
671-EWEC37H01600100	Ø160	Ø100	94€
671-EWEC37H01600130	Ø160	Ø130	95€
671-EWEC37H01600150	Ø160	Ø150	36.8€
671-EWEC37H01600180	Ø160	Ø180	92€
671-EWEC37H01600200	Ø160	Ø200	105€
671-EWEC37H01750080	Ø175	Ø80	167€
671-EWEC37H01750130	Ø175	Ø130	95€
671-EWEC37H01750150	Ø175	Ø150	93€
671-EWEC37H01750180	Ø175	Ø180	42.96€
671-EWEC37H01750200	Ø175	Ø200	105€

671-EWEC37H01800080	Ø180	Ø80	167€
671-EWEC37H01800100	Ø180	Ø100	94€
671-EWEC37H01800130	Ø180	Ø130	95€
671-EWEC37H01800150	Ø180	Ø150	93€
671-EWEC37H01800180	Ø180	Ø180	42.96€
671-EWEC37H01800200	Ø180	Ø200	106€
671-EWEC37H01800250	Ø180	Ø250	116€
671-EWEC37H02000150	Ø200	Ø150	106€
671-EWEC37H02000180	Ø200	Ø180	106€
671-EWEC37H02000200	Ø200	Ø200	48.89€
671-EWEC37H02000250	Ø200	Ø250	119€
671-EWEC37H02000300	Ø200	Ø300	158€
671-EWEC37H02250180	Ø225	Ø180	114€
671-EWEC37H02250200	Ø225	Ø200	115€
671-EWEC37H02250250	Ø225	Ø250	119€
671-EWEC37H02250300	Ø225	Ø300	158€
671-EWEC37H02500180	Ø250	Ø180	114€
671-EWEC37H02500200	Ø250	Ø200	115€
671-EWEC37H02500250	Ø250	Ø250	62€
671-EWEC37H02500300	Ø250	Ø300	160€
671-EWEC37H02500350	Ø250	Ø350	159€
671-EWEC37H03000200	Ø300	Ø200	150€
671-EWEC37H03000250	Ø300	Ø250	158€
671-EWEC37H03000300	Ø300	Ø300	76€
671-EWEC37H03000350	Ø300	Ø350	162€
671-EWEC37H03000400	Ø300	Ø400	184€
671-EWEC37H03500250	Ø350	Ø250	180€
671-EWEC37H03500300	Ø350	Ø300	190€
671-EWEC37H03500350	Ø350	Ø350	82€
671-EWEC37H03500400	Ø350	Ø400	193€
671-EWEC37H03500450	Ø350	Ø450	304€
671-EWEC37H04000300	Ø400	Ø300	210€
671-EWEC37H04000350	Ø400	Ø350	192€
671-EWEC37H04000400	Ø400	Ø400	90€
671-EWEC37H04000450	Ø400	Ø450	308€
671-EWEC37H04000500	Ø400	Ø500	411€
671-EWEC37H04500350	Ø450	Ø350	255€
671-EWEC37H04500400	Ø450	Ø400	262€
671-EWEC37H04500450	Ø450	Ø450	124€
671-EWEC37H04500500	Ø450	Ø500	421€
671-EWEC37H04500550	Ø450	Ø550	747€
671-EWEC37H05000400	Ø500	Ø400	267€
671-EWEC37H05000450	Ø500	Ø450	317€
671-EWEC37H05000500	Ø500	Ø500	175€
671-EWEC37H05000550	Ø500	Ø550	756€
671-EWEC37H05000600	Ø500	Ø600	789€
671-EWEC37H05500450	Ø550	Ø450	458€
671-EWEC37H05500500	Ø550	Ø500	611€
671-EWEC37H05500550	Ø550	Ø550	245€
671-EWEC37H05500600	Ø550	Ø600	797€
671-EWEC37H05500650	Ø550	Ø650	853€
671-EWEC37H06000500	Ø600	Ø500	630€
671-EWEC37H06000550	Ø600	Ø550	796€
671-EWEC37H06000600	Ø600	Ø600	286€
671-EWEC37H06000650	Ø600	Ø650	864€
671-EWEC37H06000700	Ø600	Ø700	916€
671-EWEC37H06500650	Ø650	Ø650	311€
671-EWEC37H06500700	Ø650	Ø700	930€
671-EWEC37H06500750	Ø650	Ø750	982€
671-EWEC37H07000700	Ø700	Ø700	338€
671-EWEC37H07000750	Ø700	Ø750	997€
671-EWEC37H07000800	Ø700	Ø800	1050€
671-EWEC37H07500750	Ø750	Ø750	362€
671-EWEC37H07500800	Ø750	Ø800	1064€
671-EWEC37H08000800	Ø800	Ø800	387€



CHIMENEA INDIVIDUAL

Sistema EW - ECO 316

ADAPTADOR CALDERA MACHO

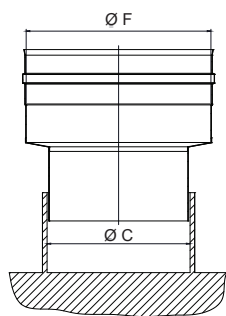

CÓDIGO	Ø A	Ø B	€
671-EWEC37M00800080	Ø80	Ø80	26.08€
671-EWEC37M00800100	Ø80	Ø100	62€
671-EWEC37M00800130	Ø80	Ø130	63€
671-EWEC37M01000080	Ø100	Ø80	63€
671-EWEC37M01000100	Ø100	Ø100	27.59€
671-EWEC37M01000130	Ø100	Ø130	67€
671-EWEC37M01000150	Ø100	Ø150	77€
671-EWEC37M01100080	Ø110	Ø80	63€
671-EWEC37M01100100	Ø110	Ø100	67€
671-EWEC37M01100130	Ø110	Ø130	67€
671-EWEC37M01100150	Ø110	Ø150	77€
671-EWEC37M01200080	Ø120	Ø80	67€
671-EWEC37M01200100	Ø120	Ø100	67€
671-EWEC37M01200130	Ø120	Ø130	67€
671-EWEC37M01200150	Ø120	Ø150	77€
671-EWEC37M01250080	Ø125	Ø80	67€
671-EWEC37M01250100	Ø125	Ø100	67€
671-EWEC37M01250130	Ø125	Ø130	30.65€
671-EWEC37M01250150	Ø125	Ø150	77€
671-EWEC37M01300080	Ø130	Ø80	67€
671-EWEC37M01300100	Ø130	Ø100	67€
671-EWEC37M01300130	Ø130	Ø130	30.65€
671-EWEC37M01300150	Ø130	Ø150	79€
671-EWEC37M01300180	Ø130	Ø180	92€
671-EWEC37M01350100	Ø135	Ø100	80€
671-EWEC37M01350130	Ø135	Ø130	30.65€
671-EWEC37M01350150	Ø135	Ø150	79€
671-EWEC37M01350180	Ø135	Ø180	92€
671-EWEC37M01400100	Ø140	Ø100	80€
671-EWEC37M01400130	Ø140	Ø130	82€
671-EWEC37M01400150	Ø140	Ø150	36.8€
671-EWEC37M01400180	Ø140	Ø180	92€
671-EWEC37M01500100	Ø150	Ø100	80€
671-EWEC37M01500130	Ø150	Ø130	82€
671-EWEC37M01500150	Ø150	Ø150	36.8€
671-EWEC37M01500180	Ø150	Ø180	92€
671-EWEC37M01500200	Ø150	Ø200	105€
671-EWEC37M01600130	Ø160	Ø130	95€
671-EWEC37M01600150	Ø160	Ø150	36.8€
671-EWEC37M01600180	Ø160	Ø180	92€
671-EWEC37M01600200	Ø160	Ø200	105€
671-EWEC37M01750130	Ø175	Ø130	95€
671-EWEC37M01750150	Ø175	Ø150	93€
671-EWEC37M01750180	Ø175	Ø180	42.96€
671-EWEC37M01750200	Ø175	Ø200	105€
671-EWEC37M01800130	Ø180	Ø130	95€
671-EWEC37M01800150	Ø180	Ø150	93€
671-EWEC37M01800180	Ø180	Ø180	42.96€
671-EWEC37M01800200	Ø180	Ø200	106€
671-EWEC37M01800250	Ø180	Ø250	116€
671-EWEC37M02000150	Ø200	Ø150	106€

671-EWEC37M02000180	Ø200	Ø180	106€
671-EWEC37M02000200	Ø200	Ø200	48.89€
671-EWEC37M02000250	Ø200	Ø250	119€
671-EWEC37M02000300	Ø200	Ø300	158€
671-EWEC37M02250180	Ø225	Ø180	114€
671-EWEC37M02250200	Ø225	Ø200	115€
671-EWEC37M02250250	Ø225	Ø250	119€
671-EWEC37M02250300	Ø225	Ø300	158€
671-EWEC37M02500180	Ø250	Ø180	114€
671-EWEC37M02500200	Ø250	Ø200	115€
671-EWEC37M02500250	Ø250	Ø250	62€
671-EWEC37M02500300	Ø250	Ø300	160€
671-EWEC37M02500350	Ø250	Ø350	159€
671-EWEC37M03000250	Ø300	Ø250	158€
671-EWEC37M03000300	Ø300	Ø300	76€
671-EWEC37M03000350	Ø300	Ø350	162€
671-EWEC37M03000400	Ø300	Ø400	184€
671-EWEC37M03500250	Ø350	Ø250	180€
671-EWEC37M03500300	Ø350	Ø300	190€
671-EWEC37M03500350	Ø350	Ø350	82€
671-EWEC37M03500400	Ø350	Ø400	193€
671-EWEC37M03500450	Ø350	Ø450	304€
671-EWEC37M04000300	Ø400	Ø300	210€
671-EWEC37M04000350	Ø400	Ø350	192€
671-EWEC37M04000400	Ø400	Ø400	90€
671-EWEC37M04000450	Ø400	Ø450	308€
671-EWEC37M04000500	Ø400	Ø500	411€
671-EWEC37M04500350	Ø450	Ø350	255€
671-EWEC37M04500400	Ø450	Ø400	262€
671-EWEC37M04500450	Ø450	Ø450	124€
671-EWEC37M04500500	Ø450	Ø500	421€
671-EWEC37M04500550	Ø450	Ø550	747€
671-EWEC37M05000400	Ø500	Ø400	267€
671-EWEC37M05000450	Ø500	Ø450	317€
671-EWEC37M05000500	Ø500	Ø500	175€
671-EWEC37M05000550	Ø500	Ø550	756€
671-EWEC37M05000600	Ø500	Ø600	789€
671-EWEC37M05500450	Ø550	Ø450	458€
671-EWEC37M05500500	Ø550	Ø500	611€
671-EWEC37M05500550	Ø550	Ø550	245€
671-EWEC37M05500600	Ø550	Ø600	797€
671-EWEC37M05500650	Ø550	Ø650	853€
671-EWEC37M06000500	Ø600	Ø500	630€
671-EWEC37M06000550	Ø600	Ø550	796€
671-EWEC37M06000600	Ø600	Ø600	286€
671-EWEC37M06000650	Ø600	Ø650	864€
671-EWEC37M06000700	Ø600	Ø700	916€
671-EWEC37M06500650	Ø650	Ø650	311€
671-EWEC37M06500700	Ø650	Ø700	930€
671-EWEC37M06500750	Ø650	Ø750	982€
671-EWEC37M07000700	Ø700	Ø700	338€
671-EWEC37M07000750	Ø700	Ø750	997€
671-EWEC37M07000800	Ø700	Ø800	1050€
671-EWEC37M07500750	Ø750	Ø750	362€
671-EWEC37M07500800	Ø750	Ø800	1064€
671-EWEC37M08000800	Ø800	Ø800	387€

AMPLIACIONES

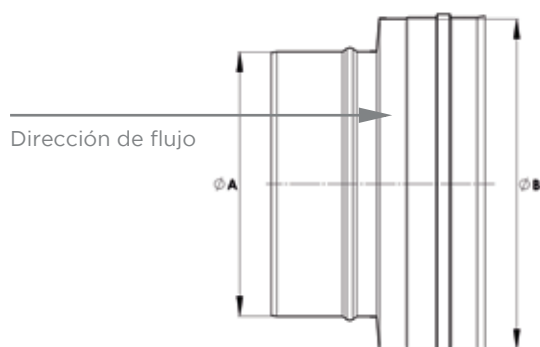

CÓDIGO	Ø A	Ø B	€
671-EWECA00800100	Ø80	Ø100	76€
671-EWECA00800130	Ø80	Ø130	92€
671-EWECA00800150	Ø80	Ø150	105€
671-EWECA00800180	Ø80	Ø180	124€
671-EWECA01000130	Ø100	Ø130	90€
671-EWECA01000150	Ø100	Ø150	103€
671-EWECA01000180	Ø100	Ø180	119€
671-EWECA01000200	Ø100	Ø200	159€
671-EWECA01250130	Ø125	Ø130	80€
671-EWECA01250150	Ø125	Ø150	95€
671-EWECA01250180	Ø125	Ø180	114€
671-EWECA01250200	Ø125	Ø200	151€
671-EWECA01250250	Ø125	Ø250	188€
671-EWECA01300150	Ø130	Ø150	90€
671-EWECA01300180	Ø130	Ø180	111€
671-EWECA01300200	Ø130	Ø200	147€
671-EWECA01300250	Ø130	Ø250	179€
671-EWECA01300300	Ø130	Ø300	242€
671-EWECA01500180	Ø150	Ø180	100€
671-EWECA01500200	Ø150	Ø200	142€
671-EWECA01500250	Ø150	Ø250	174€
671-EWECA01500300	Ø150	Ø300	233€
671-EWECA01500350	Ø150	Ø350	274€
671-EWECA01800200	Ø180	Ø200	129€
671-EWECA01800250	Ø180	Ø250	167€
671-EWECA01800300	Ø180	Ø300	225€
671-EWECA01800350	Ø180	Ø350	262€
671-EWECA01800400	Ø180	Ø400	288€
671-EWECA02000250	Ø200	Ø250	150€
671-EWECA02000300	Ø200	Ø300	213€
671-EWECA02000350	Ø200	Ø350	252€
671-EWECA02000400	Ø200	Ø400	279€
671-EWECA02000450	Ø200	Ø450	315€
671-EWECA02500300	Ø250	Ø300	194€
671-EWECA02500350	Ø250	Ø350	238€
671-EWECA02500400	Ø250	Ø400	270€
671-EWECA02500450	Ø250	Ø450	304€
671-EWECA02500500	Ø250	Ø500	342€
671-EWECA03000350	Ø300	Ø350	220€

671-EWECA03000400	Ø300	Ø400	255€
671-EWECA03000450	Ø300	Ø450	287€
671-EWECA03000500	Ø300	Ø500	324€
671-EWECA03000550	Ø300	Ø550	349€
671-EWECA03500400	Ø350	Ø400	233€
671-EWECA03500450	Ø350	Ø450	278€
671-EWECA03500500	Ø350	Ø500	311€
671-EWECA03500550	Ø350	Ø550	340€
671-EWECA03500600	Ø350	Ø600	387€
671-EWECA04000450	Ø400	Ø450	252€
671-EWECA04000500	Ø400	Ø500	299€
671-EWECA04000550	Ø400	Ø550	323€
671-EWECA04000600	Ø400	Ø600	369€
671-EWECA04000650	Ø400	Ø650	411€
671-EWECA04500500	Ø450	Ø500	273€
671-EWECA04500550	Ø450	Ø550	310€
671-EWECA04500600	Ø450	Ø600	353€
671-EWECA04500650	Ø450	Ø650	392€
671-EWECA04500700	Ø450	Ø700	509€
671-EWECA05000550	Ø500	Ø550	281€
671-EWECA05000600	Ø500	Ø600	342€
671-EWECA05000650	Ø500	Ø650	377€
671-EWECA05000700	Ø500	Ø700	487€
671-EWECA05000750	Ø500	Ø750	534€
671-EWECA05500600	Ø550	Ø600	309€
671-EWECA05500650	Ø550	Ø650	362€
671-EWECA05500700	Ø550	Ø700	471€
671-EWECA05500750	Ø550	Ø750	510€
671-EWECA05500800	Ø550	Ø800	582€
671-EWECA06000650	Ø600	Ø650	328€
671-EWECA06000700	Ø600	Ø700	446€
671-EWECA06000750	Ø600	Ø750	490€
671-EWECA06000800	Ø600	Ø800	558€
671-EWECA06500700	Ø650	Ø700	405€
671-EWECA06500750	Ø650	Ø750	471€
671-EWECA06500800	Ø650	Ø800	535€
671-EWECA07000750	Ø700	Ø750	427€
671-EWECA07000800	Ø700	Ø800	510€
671-EWECA07500800	Ø750	Ø800	468€



CHIMENEA INDIVIDUAL

Sistema EW - ECO 316

REDUCCIONES

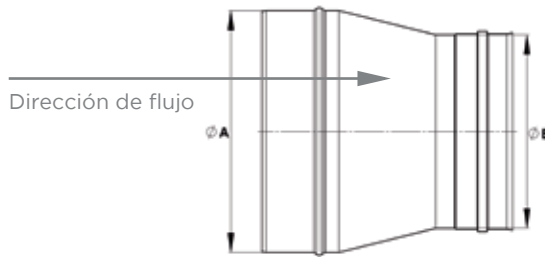

CÓDIGO	Ø A	Ø B	€
671-EWECR01000080	Ø100	Ø80	76€
671-EWECR01250080	Ø125	Ø80	90€
671-EWECR01250100	Ø125	Ø100	80€
671-EWECR01300080	Ø130	Ø80	92€
671-EWECR01300100	Ø130	Ø100	90€
671-EWECR01500080	Ø150	Ø80	105€
671-EWECR01500100	Ø150	Ø100	103€
671-EWECR01500130	Ø150	Ø130	90€
671-EWECR01800080	Ø180	Ø80	124€
671-EWECR01800100	Ø180	Ø100	119€
671-EWECR01800130	Ø180	Ø130	111€
671-EWECR01800150	Ø180	Ø150	100€
671-EWECR02000100	Ø200	Ø100	159€
671-EWECR02000130	Ø200	Ø130	147€
671-EWECR02000150	Ø200	Ø150	142€
671-EWECR02000180	Ø200	Ø180	129€
671-EWECR03000250	Ø300	Ø250	194€
671-EWECR03500250	Ø350	Ø250	238€
671-EWECR03500300	Ø350	Ø300	220€
671-EWECR04000250	Ø400	Ø250	270€
671-EWECR04000300	Ø400	Ø300	255€
671-EWECR04000350	Ø400	Ø350	233€
671-EWECR04500250	Ø450	Ø250	304€
671-EWECR04500300	Ø450	Ø300	287€
671-EWECR04500350	Ø450	Ø350	278€
671-EWECR04500400	Ø450	Ø400	252€
671-EWECR05000250	Ø500	Ø250	342€
671-EWECR05000300	Ø500	Ø300	324€
671-EWECR05000350	Ø500	Ø350	311€
671-EWECR05000400	Ø500	Ø400	299€

671-EWECR05000450	Ø500	Ø450	273€
671-EWECR05500300	Ø550	Ø300	349€
671-EWECR05500350	Ø550	Ø350	340€
671-EWECR05500400	Ø550	Ø400	323€
671-EWECR05500450	Ø550	Ø450	310€
671-EWECR05500500	Ø550	Ø500	281€
671-EWECR06000350	Ø600	Ø350	387€
671-EWECR06000400	Ø600	Ø400	369€
671-EWECR06000450	Ø600	Ø450	353€
671-EWECR06000500	Ø600	Ø500	342€
671-EWECR06000550	Ø600	Ø550	309€
671-EWECR06500400	Ø650	Ø400	411€
671-EWECR06500450	Ø650	Ø450	392€
671-EWECR06500500	Ø650	Ø500	377€
671-EWECR06500550	Ø650	Ø550	362€
671-EWECR06500600	Ø650	Ø600	328€
671-EWECR07000450	Ø700	Ø450	509€
671-EWECR07000500	Ø700	Ø500	487€
671-EWECR07000550	Ø700	Ø550	471€
671-EWECR07000600	Ø700	Ø600	446€
671-EWECR07000650	Ø700	Ø650	405€
671-EWECR07500500	Ø750	Ø500	534€
671-EWECR07500550	Ø750	Ø550	510€
671-EWECR07500600	Ø750	Ø600	490€
671-EWECR07500650	Ø750	Ø650	471€
671-EWECR07500700	Ø750	Ø700	427€
671-EWECR08000550	Ø800	Ø550	582€
671-EWECR08000600	Ø800	Ø600	558€
671-EWECR08000650	Ø800	Ø650	535€
671-EWECR08000700	Ø800	Ø700	510€
671-EWECR08000750	Ø800	Ø750	468€