



# CHIMENEA INDIVIDUAL

## Sistema DW - ECO 1.0 316

**Chimenea modular metálica para evacuación de humos y gases de los productos de la combustión de doble pared fabricada en acero inoxidable interior y exterior.**

### MATERIAL

Pared Interior: AISI 316L  
Pared Exterior: AISI 304

### ACABADO EXTERIOR

Brillante  
Colores RAL (consulta página 14 para acabados especiales)  
Exterior galvanizado -15% (sólo tramos rectos y desviaciones)

### AISLAMIENTO

Lana de roca rígida de alta densidad (120kg/m<sup>3</sup>)

### ESPESORES (mm)

Pared interior: 0,4 mm  
Aislamiento: 25 mm  
Pared exterior: 0,4 mm

### DIÁMETROS DISPONIBLES (mm)

Ø80 a Ø200

### SISTEMA DE UNIÓN

Conexión macho-hembra con **abrazadera de unión sencilla**

### NIVEL DE ESTANQUEIDAD

Txxx - N1: Sin necesidad de junta  
T120 - H1: Incluir junta de condensación (DW2526CØ)\*.  
T200 - H1: Incluir junta de estanqueidad (DW2526Ø)\*.

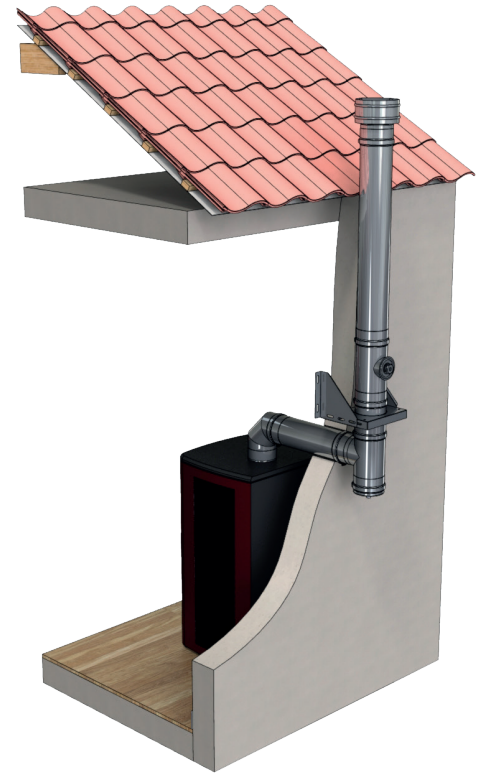

Para incluir la junta de condensación (T<120°C) preinstalada de fábrica, sustituir el código del sistema 909 por B11\*.  
Para incluir la junta de estanqueidad (T<200°C) preinstalada de fábrica, sustituir el código del sistema 909 por B01\*.  
Excepto terminales



## APLICACIONES

- Calderas de condensación
- Calderas y estufas de combustibles sólidos
- Fuegos bajos
- Hornos
- Cocinas de leña



## CARACTERÍSTICAS

- Temperatura de trabajo hasta 600°C
- **Soldadura TIG/LÁSER** en continuo en todas las piezas
- **Abrazadera de unión incluida (excepto terminales)**
- Posibilidad de **corte de módulos rectos a medida** en obra (ver instrucciones de corte página 53)
- **Para condensación es necesaria la junta de condensación (DW2526C) en las uniones y una pendiente mínima de 3° en tramos horizontales (T<120°C)**
- Chimenea con clasificación de **resistencia al fuego**

### CERTIFICADO CE

0036 CPR 9174 030  
0036 CPR 9174 044

### CLASIFICACIONES CE (UNE-EN 1856-1)

T600 - N1 - D - V3 - L50040 - G(70)  
T450 - N1 - D - V3 - L50040 - G(60)  
T400 - N1 - W - V2 - L50040 - O(30)  
T200 - H1 - W - V2 - L50040 - O(20) (con junta de estanqueidad DW2526)  
T120 - H1 - W - V2 - L50040 - O(00) (con junta de condensación DW2526C)

### CLASIFICACIONES DE RESISTENCIA AL FUEGO SEGÚN EN 13501-2

EI180 ve (o-->i) T200  
EI120 ve (o-->i) T600  
EI120 ho (o-->i) T600



Módulo recto 1000mm



Módulo recto 500mm



Módulo recto 250mm



Módulo recto 250mm con  
desagüe lateral



Módulo recto regulable  
400-560mm

Ø80	909-DWECO130080	148€	Ø80	909-DWECO140080	105€	Ø80	909-DWECO150080	77€	Ø80	909-DWECO15D0080	106€	Ø80	909-DWECO5440080	148€
Ø100	909-DWECO130100	153€	Ø100	909-DWECO140100	113€	Ø100	909-DWECO150100	80€	Ø100	909-DWECO15D0100	115€	Ø100	909-DWECO5440100	153€
Ø130	909-DWECO130130	159€	Ø130	909-DWECO140130	115€	Ø130	909-DWECO150130	82€	Ø130	909-DWECO15D0130	123€	Ø130	909-DWECO5440130	159€
Ø150	909-DWECO130150	178€	Ø150	909-DWECO140150	131€	Ø150	909-DWECO150150	90€	Ø150	909-DWECO15D0150	132€	Ø150	909-DWECO5440150	177€
Ø180	909-DWECO130180	214€	Ø180	909-DWECO140180	153€	Ø180	909-DWECO150180	104€	Ø180	909-DWECO15D0180	150€	Ø180	909-DWECO5440180	207€
Ø200	909-DWECO130200	252€	Ø200	909-DWECO140200	179€	Ø200	909-DWECO150200	121€	Ø200	909-DWECO15D0200	167€	Ø200	909-DWECO5440200	237€



Módulo recto regulable  
560-920mm



Codo 15°



Codo 30°



Codo 45°



Codo 60°

Ø80	909-DWECO5450080	222€	Ø80	909-DWECO160080	105€	Ø80	909-DWECO170080	105€	Ø80	909-DWECO180080	105€	Ø80	909-DWECO840080	131€
Ø100	909-DWECO5450100	231€	Ø100	909-DWECO160100	113€	Ø100	909-DWECO170100	113€	Ø100	909-DWECO180100	113€	Ø100	909-DWECO840100	135€
Ø130	909-DWECO5450130	237€	Ø130	909-DWECO160130	115€	Ø130	909-DWECO170130	115€	Ø130	909-DWECO180130	115€	Ø130	909-DWECO840130	142€
Ø150	909-DWECO5450150	264€	Ø150	909-DWECO160150	129€	Ø150	909-DWECO170150	129€	Ø150	909-DWECO180150	129€	Ø150	909-DWECO840150	156€
Ø180	909-DWECO5450180	310€	Ø180	909-DWECO160180	148€	Ø180	909-DWECO170180	148€	Ø180	909-DWECO180180	148€	Ø180	909-DWECO840180	180€
Ø200	909-DWECO5450200	356€	Ø200	909-DWECO160200	173€	Ø200	909-DWECO170200	173€	Ø200	909-DWECO180200	173€	Ø200	909-DWECO840200	208€



Codo 87°



Codo 90°



Te 87°



Te 90°



Te 135°

Ø80	909-DWECO640080	151€	Ø80	909-DWECO600080	151€	Ø80	909-DWECO110080	258€	Ø80	909-DWECO3170080	221€	Ø80	909-DWECO120080	315€
Ø100	909-DWECO640100	159€	Ø100	909-DWECO600100	159€	Ø100	909-DWECO110100	271€	Ø100	909-DWECO3170100	230€	Ø100	909-DWECO120100	328€
Ø130	909-DWECO640130	162€	Ø130	909-DWECO600130	162€	Ø130	909-DWECO110130	280€	Ø130	909-DWECO3170130	236€	Ø130	909-DWECO120130	340€
Ø150	909-DWECO640150	184€	Ø150	909-DWECO600150	184€	Ø150	909-DWECO110150	311€	Ø150	909-DWECO3170150	255€	Ø150	909-DWECO120150	378€
Ø180	909-DWECO640180	210€	Ø180	909-DWECO600180	210€	Ø180	909-DWECO110180	362€	Ø180	909-DWECO3170180	301€	Ø180	909-DWECO120180	441€
Ø200	909-DWECO640200	245€	Ø200	909-DWECO600200	245€	Ø200	909-DWECO110200	421€	Ø200	909-DWECO3170200	349€	Ø200	909-DWECO120200	523€



# CHIMENEA INDIVIDUAL

## Sistema DW - ECO 1.0 316



Te pellets



Colector de hollín



Colector de hollín aislado



Colector de hollín con desagüe

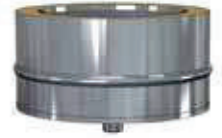

Colector de hollín con desagüe aislado

Ø80	909-DWECO12970080	170€	Ø80	909-DWECO5510080	39.98€	Ø80	909-DWECO20330080	62€	Ø80	909-DWECO440080	48.89€	Ø80	909-DWECO14600080	79€
Ø100	909-DWECO12970100	175€	Ø100	909-DWECO5510100	42.96€	Ø100	909-DWECO20330100	72€	Ø100	909-DWECO440100	50€	Ø100	909-DWECO14600100	85€
Ø130	-	-	Ø130	909-DWECO5510130	50€	Ø130	909-DWECO20330130	80€	Ø130	909-DWECO440130	61€	Ø130	909-DWECO14600130	93€
Ø150	-	-	Ø150	909-DWECO5510150	58€	Ø150	909-DWECO20330150	91€	Ø150	909-DWECO440150	70€	Ø150	909-DWECO14600150	105€
Ø180	-	-	Ø180	909-DWECO5510180	63€	Ø180	909-DWECO20330180	104€	Ø180	909-DWECO440180	74€	Ø180	909-DWECO14600180	119€
Ø200	-	-	Ø200	909-DWECO5510200	72€	Ø200	909-DWECO20330200	116€	Ø200	909-DWECO440200	82€	Ø200	909-DWECO14600200	133€



Colector de hollín con desagüe lateral



Codo 87° con inspección P1



Codo 90° con tapa de inspección P1



Módulo de inspección



Módulo de inspección con tapa 200 Pa (P1)

Ø80	909-DWECO10080	114€	Ø80	909-DWECO67AL0080	299€	Ø80	909-DWECO19AL0080	299€	Ø80	909-DWECO5430080	129€	Ø80	909-DWECO5490080	206€
Ø100	909-DWECO10100	123€	Ø100	909-DWECO67AL0100	309€	Ø100	909-DWECO19AL0100	309€	Ø100	909-DWECO5430100	132€	Ø100	909-DWECO5490100	225€
Ø130	909-DWECO10130	135€	Ø130	909-DWECO67AL0130	318€	Ø130	909-DWECO19AL0130	318€	Ø130	909-DWECO5430130	135€	Ø130	909-DWECO5490130	236€
Ø150	909-DWECO10150	146€	Ø150	909-DWECO67AL0150	332€	Ø150	909-DWECO19AL0150	332€	Ø150	909-DWECO5430150	151€	Ø150	909-DWECO5490150	246€
Ø180	909-DWECO10180	160€	Ø180	909-DWECO67AL0180	387€	Ø180	909-DWECO19AL0180	387€	Ø180	909-DWECO5430180	177€	Ø180	909-DWECO5490180	258€
Ø200	909-DWECO10200	173€	Ø200	909-DWECO67AL0200	416€	Ø200	909-DWECO19AL0200	416€	Ø200	909-DWECO5430200	203€	Ø200	909-DWECO5490200	272€



Módulo de inspección con tapa 40 Pa (N1)



Módulo temperatura humos



Terminal salida libre



Terminal salida cónica



Terminal anti-lluvia

Ø80	909-DWECO680080	206€	Ø80	909-DWECO870080	523€	Ø80	909-DWECO320080	70€	Ø80	909-DWECO32C0080	80€	Ø80	909-DWECO5260080	94€
Ø100	909-DWECO680100	225€	Ø100	909-DWECO870100	544€	Ø100	909-DWECO320100	72€	Ø100	909-DWECO32C0100	82€	Ø100	909-DWECO5260100	100€
Ø130	909-DWECO680130	236€	Ø130	909-DWECO870130	562€	Ø130	909-DWECO320130	74€	Ø130	909-DWECO32C0130	84€	Ø130	909-DWECO5260130	103€
Ø150	909-DWECO680150	246€	Ø150	909-DWECO870150	626€	Ø150	909-DWECO320150	84€	Ø150	909-DWECO32C0150	94€	Ø150	909-DWECO5260150	115€
Ø180	909-DWECO680180	258€	Ø180	909-DWECO870180	715€	Ø180	909-DWECO320180	94€	Ø180	909-DWECO32C0180	111€	Ø180	909-DWECO5260180	133€
Ø200	909-DWECO680200	272€	Ø200	909-DWECO870200	775€	Ø200	909-DWECO320200	113€	Ø200	909-DWECO32C0200	129€	Ø200	909-DWECO5260200	153€



Terminal anti-viento



Terminal horizontal con rejilla



Terminal GAS light



Regulador de tiro



Estabilizador de tiro (adaptador + clapeta)

Ø80	909-DWECO5270080	138€	Ø80	909-DWECO5320080	89€	Ø80	909-DWECO4350080	208€	Ø80	909-DWECO5310080	222€	Ø80	909-DWECO9700080	230€
Ø100	909-DWECO5270100	144€	Ø100	909-DWECO5320100	89€	Ø100	909-DWECO43500100	221€	Ø100	909-DWECO5310100	231€	Ø100	909-DWECO9700100	242€
Ø130	909-DWECO5270130	148€	Ø130	909-DWECO5320130	91€	Ø130	909-DWECO43500130	242€	Ø130	909-DWECO5310130	237€	Ø130	909-DWECO9700130	253€
Ø150	909-DWECO5270150	163€	Ø150	909-DWECO5320150	103€	Ø150	909-DWECO43500150	273€	Ø150	909-DWECO5310150	264€	Ø150	909-DWECO9700150	324€
Ø180	909-DWECO5270180	193€	Ø180	909-DWECO5320180	121€	Ø180	909-DWECO43500180	298€	Ø180	909-DWECO5310180	310€	Ø180	909-DWECO9700180	358€
Ø200	909-DWECO5270200	222€	Ø200	909-DWECO5320200	142€	Ø200	909-DWECO43500200	332€	Ø200	909-DWECO5310200	356€	Ø200	909-DWECO9700200	377€



Adaptador a Hurricane



Adaptador doble a simple



Adaptador simple a doble



Placa base con desagüe lateral



Soporte de carga regulable

Ø80	-	-	Ø80	909-DWECO37A0080	47.4€	Ø80	909-DWECO370080	47.4€	Ø80	909-DWECO60080	210€	Ø80	909-DWECO3790080	192€
Ø100	-	-	Ø100	909-DWECO37A0100	52€	Ø100	909-DWECO370100	52€	Ø100	909-DWECO60100	221€	Ø100	909-DWECO3790100	199€
Ø130	909-DWECO44760130	150€	Ø130	909-DWECO37A0130	52€	Ø130	909-DWECO370130	52€	Ø130	909-DWECO60130	228€	Ø130	909-DWECO3790130	203€
Ø150	909-DWECO44760150	175€	Ø150	909-DWECO37A0150	61€	Ø150	909-DWECO370150	61€	Ø150	909-DWECO60150	255€	Ø150	909-DWECO3790150	228€
Ø180	909-DWECO44760180	207€	Ø180	909-DWECO37A0180	72€	Ø180	909-DWECO370180	72€	Ø180	909-DWECO60180	267€	Ø180	909-DWECO3790180	267€
Ø200	909-DWECO44760200	221€	Ø200	909-DWECO37A0200	82€	Ø200	909-DWECO370200	82€	Ø200	909-DWECO60200	301€	Ø200	909-DWECO3790200	308€



Pasamuros EI



Abrazadera de unión 1.0



Abrazadera fijación pared regulable 50-80mm



Base de abrazadera distanciadora



Alas distanciadoras A

Ø80	909-DWECO4330080	461€	Ø80	665-ZUWA450130	6.15€	Ø80	665-ZUWA5560130	35.28€	Ø80	665-ZUWA14620130	42.96€	Ø80	665-ZUWA1462A	44.43€
Ø100	909-DWECO43300100	475€	Ø100	665-ZUWA450150	7.68€	Ø100	665-ZUWA5560150	36.8€	Ø100	665-ZUWA14620150	45.92€	Ø100		
Ø130	909-DWECO43300130	496€	Ø130	665-ZUWA450180	9.19€	Ø130	665-ZUWA5560180	36.8€	Ø130	665-ZUWA14620180	48.89€	Ø130		
Ø150	909-DWECO43300150	481€	Ø150	665-ZUWA450200	10.73€	Ø150	665-ZUWA5560200	42.96€	Ø150	665-ZUWA14620200	54€	Ø150		
Ø180	909-DWECO43300180	573€	Ø180	665-ZUWA450230	13.81€	Ø180	665-ZUWA5560230	48.89€	Ø180	665-ZUWA14620230	73€	Ø180		
Ø200	909-DWECO43300200	637€	Ø200	665-ZUWA450250	19.94€	Ø200	665-ZUWA5560250	57€	Ø200	665-ZUWA14620250	94€	Ø200		



# CHIMENEA INDIVIDUAL

## Sistema DW - ECO 1.0 316

**i**

Alas distanciadoras B

**i**

Alas distanciadoras C

**i**

Alas distanciadoras D



Abrazadera de soporte



Abrazadera con doble pértiga telescópica L=2000mm

Ø80	665-ZUWA1462B	61€	Ø80	665-ZUWA1462C	77€	Ø80	665-ZUWA1462D	98€	Ø80	-	-	Ø80	665-ZUWA1910130	136€
Ø100			Ø100			Ø100			-	-	Ø100	665-ZUWA1910150	138€	
Ø130			Ø130			Ø130			665-ZUWA8580180	137€	Ø130	665-ZUWA1910180	147€	
Ø150			Ø150			Ø150			665-ZUWA8580200	137€	Ø150	665-ZUWA1910200	163€	
Ø180			Ø180			Ø180			665-ZUWA8580230	153€	Ø180	665-ZUWA1910230	169€	
Ø200			Ø200			Ø200			665-ZUWA8580250	175€	Ø200	665-ZUWA1910250	184€	



Abrazadera fijacion a techo



Abrazadera forjado inox



Abrazadera para amarre por tornillo



Abrazadera vientos



Soporte de techo

Ø80	665-ZUWA118B0130	36.8€	Ø80	665-ZUWA620130	24.54€	Ø80	665-ZUWA10630130	30.65€	Ø80	665-ZUWA420130	10.73€	Ø80	665-ZUWA9360130	32.19€
Ø100	665-ZUWA118B0150	39.98€	Ø100	665-ZUWA620150	29.13€	Ø100	665-ZUWA10630150	33.72€	Ø100	665-ZUWA420150	13.81€	Ø100	665-ZUWA9360150	38.52€
Ø130	665-ZUWA118B0180	45.92€	Ø130	665-ZUWA620180	39.98€	Ø130	665-ZUWA10630180	36.8€	Ø130	665-ZUWA420180	19.94€	Ø130	665-ZUWA9360180	47.4€
Ø150	665-ZUWA118B0200	55€	Ø150	665-ZUWA620200	44.43€	Ø150	665-ZUWA10630200	39.98€	Ø150	665-ZUWA420200	24.54€	Ø150	665-ZUWA9360200	52€
Ø180	665-ZUWA118B0230	62€	Ø180	665-ZUWA620230	47.4€	Ø180	665-ZUWA10630230	47.4€	Ø180	665-ZUWA420230	26.08€	Ø180	665-ZUWA9360230	61€
Ø200	665-ZUWA118B0250	62€	Ø200	665-ZUWA620250	47.4€	Ø200	665-ZUWA10630250	47.4€	Ø200	665-ZUWA420250	27.59€	Ø200	665-ZUWA9360250	69€



Collarín antitormenta

**i**

Cubreaguas 25°-45° aluminio

**i**

Cubreaguas 5°-25° aluminio

**i**

Cubreaguas plano inox

**i**

Cubreaguas plomo 0°-5°

Ø80	665-ZUWA3070130	27.59€	Ø80	665-ZUWA939AL0130	207€	Ø80	665-ZUWA938AL0130	194€	Ø80	665-ZUWA11280130	138€	Ø80	665-ZUWA9370130	193€
Ø100	665-ZUWA3070150	32.19€	Ø100	665-ZUWA939AL0150	219€	Ø100	665-ZUWA938AL0150	203€	Ø100	665-ZUWA11280150	142€	Ø100	665-ZUWA9370150	194€
Ø130	665-ZUWA3070180	38.52€	Ø130	665-ZUWA939AL0180	236€	Ø130	665-ZUWA938AL0180	221€	Ø130	665-ZUWA11280180	160€	Ø130	665-ZUWA9370180	220€
Ø150	665-ZUWA3070200	44.43€	Ø150	665-ZUWA939AL0200	253€	Ø150	665-ZUWA938AL0200	238€	Ø150	665-ZUWA11280200	175€	Ø150	665-ZUWA9370200	245€
Ø180	665-ZUWA3070230	48.89€	Ø180	665-ZUWA939AL0230	272€	Ø180	665-ZUWA938AL0230	246€	Ø180	665-ZUWA11280230	180€	Ø180	665-ZUWA9370230	253€
Ø200	665-ZUWA3070250	55€	Ø200	665-ZUWA939AL0250	287€	Ø200	665-ZUWA938AL0250	266€	Ø200	665-ZUWA11280250	199€	Ø200	665-ZUWA9370250	277€

- i** Precio unidad. u./c= unidad caja.
- i** Necesario instalar collarín con el cubreaguas.
- i** Consultar página 91 para ver distancias de separación.



Cubreaguas plomo 25°-45°    Cubreaguas plomo 5°-25°    Pasamuros    Soporte cubierta ventilado    Junta de silicona (T<200°C)

Ø80	665-ZUWA9390130	338€	Ø80	665-ZUWA9380130	193€	Ø80	665-ZUWA9870130	36.8€	Ø80	665-ZUWA9340130	60€	Ø80	665-ZUWA260080	4.6€
Ø100	665-ZUWA9390150	342€	Ø100	665-ZUWA9380150	194€	Ø100	665-ZUWA9870150	38.52€	Ø100	665-ZUWA9340150	63€	Ø100	665-ZUWA260100	4.6€
Ø130	665-ZUWA9390180	357€	Ø130	665-ZUWA9380180	220€	Ø130	665-ZUWA9870180	48.89€	Ø130	665-ZUWA9340180	67€	Ø130	665-ZUWA260130	4.6€
Ø150	665-ZUWA9390200	364€	Ø150	665-ZUWA9380200	245€	Ø150	665-ZUWA9870200	48.89€	Ø150	665-ZUWA9340200	74€	Ø150	665-ZUWA260150	4.6€
Ø180	665-ZUWA9390230	374€	Ø180	665-ZUWA9380230	253€	Ø180	665-ZUWA9870230	60€	Ø180	665-ZUWA9340230	89€	Ø180	665-ZUWA260180	6.15€
Ø200	665-ZUWA9390250	378€	Ø200	665-ZUWA9380250	277€	Ø200	665-ZUWA9870250	61€	Ø200	665-ZUWA9340250	101€	Ø200	665-ZUWA260200	7.68€

## ADAPTADOR CALDERA HEMBRA

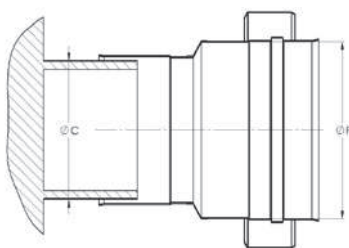

Junta EPDM (T<120°C)

Ø80	665-ZUWA26C0080	4.6€
Ø100	665-ZUWA26C0100	4.6€
Ø130	665-ZUWA26C0130	4.6€
Ø150	665-ZUWA26C0150	4.6€
Ø180	665-ZUWA26C0180	6.15€
Ø200	665-ZUWA26C0200	7.68€

CÓDIGO	Ø A	Ø B	€
909-DWECO37H00800080	Ø80	Ø80	54€
909-DWECO37H00800130	Ø80	Ø130	80€
909-DWECO37H01000080	Ø100	Ø80	84€
909-DWECO37H01000100	Ø100	Ø100	57€
909-DWECO37H01000130	Ø100	Ø130	82€
909-DWECO37H01000150	Ø100	Ø150	92€
909-DWECO37H01100080	Ø110	Ø80	84€
909-DWECO37H01100100	Ø110	Ø100	85€
909-DWECO37H01100130	Ø110	Ø130	82€
909-DWECO37H01100150	Ø110	Ø150	92€
909-DWECO37H01200080	Ø120	Ø80	85€
909-DWECO37H01200100	Ø120	Ø100	85€
909-DWECO37H01200130	Ø120	Ø130	82€
909-DWECO37H01200150	Ø120	Ø150	92€
909-DWECO37H01250080	Ø125	Ø80	85€
909-DWECO37H01250100	Ø125	Ø100	85€
909-DWECO37H01250130	Ø125	Ø130	57€
909-DWECO37H01250150	Ø125	Ø150	92€
909-DWECO37H01300080	Ø130	Ø80	85€
909-DWECO37H01300100	Ø130	Ø100	85€
909-DWECO37H01300130	Ø130	Ø130	57€
909-DWECO37H01300150	Ø130	Ø150	93€
909-DWECO37H01300180	Ø130	Ø180	114€
909-DWECO37H01350100	Ø135	Ø100	94€
909-DWECO37H01350130	Ø135	Ø130	57€
909-DWECO37H01350150	Ø135	Ø150	93€
909-DWECO37H01350180	Ø135	Ø180	114€

909-DWECO37H01400100	Ø140	Ø100	94€
909-DWECO37H01400130	Ø140	Ø130	92€
909-DWECO37H01400150	Ø140	Ø150	63€
909-DWECO37H01400180	Ø140	Ø180	115€
909-DWECO37H01500100	Ø150	Ø100	94€
909-DWECO37H01500130	Ø150	Ø130	92€
909-DWECO37H01500150	Ø150	Ø150	63€
909-DWECO37H01500180	Ø150	Ø180	115€
909-DWECO37H01500200	Ø150	Ø200	131€
909-DWECO37H01600130	Ø160	Ø130	103€
909-DWECO37H01600150	Ø160	Ø150	63€
909-DWECO37H01600180	Ø160	Ø180	115€
909-DWECO37H01600200	Ø160	Ø200	131€
909-DWECO37H01750130	Ø175	Ø130	103€
909-DWECO37H01750150	Ø175	Ø150	105€
909-DWECO37H01750180	Ø175	Ø180	77€
909-DWECO37H01750200	Ø175	Ø200	131€
909-DWECO37H01800130	Ø180	Ø130	103€
909-DWECO37H01800150	Ø180	Ø150	105€
909-DWECO37H01800180	Ø180	Ø180	77€
909-DWECO37H01800200	Ø180	Ø200	132€
909-DWECO37H02000150	Ø200	Ø150	115€
909-DWECO37H02000180	Ø200	Ø180	125€
909-DWECO37H02000200	Ø200	Ø200	89€
909-DWECO37H02250180	Ø225	Ø180	125€
909-DWECO37H02250200	Ø225	Ø200	138€
909-DWECO37H02500180	Ø250	Ø180	125€
909-DWECO37H02500200	Ø250	Ø200	138€





# CHIMENEA INDIVIDUAL

## Sistema DW - ECO 1.0 316

### ADAPTADOR CALDERA MACHO

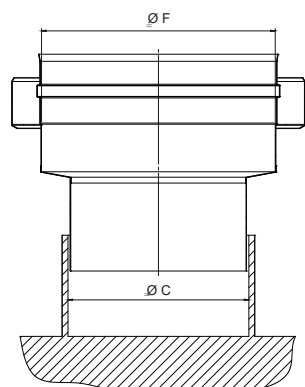

CÓDIGO	Ø A	Ø B	€
909-DWECO37M00800080	Ø80	Ø80	54€
909-DWECO37M00800100	Ø80	Ø100	82€
909-DWECO37M00800130	Ø80	Ø130	80€
909-DWECO37M01000080	Ø100	Ø80	84€
909-DWECO37M01000100	Ø100	Ø100	57€
909-DWECO37M01000130	Ø100	Ø130	82€
909-DWECO37M01000150	Ø100	Ø150	92€
909-DWECO37M01100080	Ø110	Ø80	84€
909-DWECO37M01100100	Ø110	Ø100	85€
909-DWECO37M01100130	Ø110	Ø130	82€
909-DWECO37M01100150	Ø110	Ø150	92€
909-DWECO37M01200080	Ø120	Ø80	85€
909-DWECO37M01200100	Ø120	Ø100	85€
909-DWECO37M01200130	Ø120	Ø130	82€
909-DWECO37M01200150	Ø120	Ø150	92€
909-DWECO37M01250080	Ø125	Ø80	85€
909-DWECO37M01250100	Ø125	Ø100	85€
909-DWECO37M01250130	Ø125	Ø130	57€
909-DWECO37M01250150	Ø125	Ø150	92€
909-DWECO37M01300080	Ø130	Ø80	85€
909-DWECO37M01300100	Ø130	Ø100	85€
909-DWECO37M01300130	Ø130	Ø130	57€
909-DWECO37M01300150	Ø130	Ø150	93€
909-DWECO37M01300180	Ø130	Ø180	114€
909-DWECO37M01350100	Ø135	Ø100	94€
909-DWECO37M01350130	Ø135	Ø130	57€
909-DWECO37M01350150	Ø135	Ø150	93€
909-DWECO37M01350180	Ø135	Ø180	114€

909-DWECO37M01400100	Ø140	Ø100	94€
909-DWECO37M01400130	Ø140	Ø130	92€
909-DWECO37M01400150	Ø140	Ø150	63€
909-DWECO37M01400180	Ø140	Ø180	115€
909-DWECO37M01500100	Ø150	Ø100	94€
909-DWECO37M01500130	Ø150	Ø130	92€
909-DWECO37M01500150	Ø150	Ø150	63€
909-DWECO37M01500180	Ø150	Ø180	115€
909-DWECO37M01500200	Ø150	Ø200	131€
909-DWECO37M01600130	Ø160	Ø130	103€
909-DWECO37M01600150	Ø160	Ø150	63€
909-DWECO37M01600180	Ø160	Ø180	115€
909-DWECO37M01600200	Ø160	Ø200	131€
909-DWECO37M01750130	Ø175	Ø130	103€
909-DWECO37M01750150	Ø175	Ø150	105€
909-DWECO37M01750180	Ø175	Ø180	77€
909-DWECO37M01750200	Ø175	Ø200	131€
909-DWECO37M01800130	Ø180	Ø130	103€
909-DWECO37M01800150	Ø180	Ø150	105€
909-DWECO37M01800180	Ø180	Ø180	77€
909-DWECO37M01800200	Ø180	Ø200	132€
909-DWECO37M02000150	Ø200	Ø150	115€
909-DWECO37M02000180	Ø200	Ø180	125€
909-DWECO37M02000200	Ø200	Ø200	89€
909-DWECO37M02250180	Ø225	Ø180	125€
909-DWECO37M02250200	Ø225	Ø200	138€
909-DWECO37M02500180	Ø250	Ø180	125€
909-DWECO37M02500200	Ø250	Ø200	138€

## AMPLIACIONES

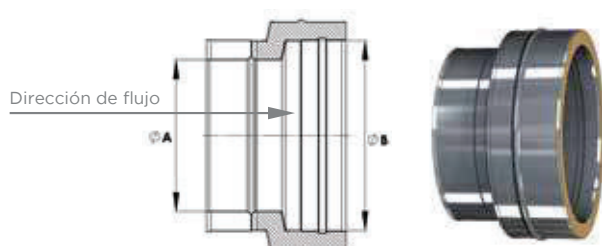

CÓDIGO	Ø A	Ø B	€
909-DWECOAX00800100	Ø80	Ø100	124€
909-DWECOAX00800130	Ø80	Ø130	177€
909-DWECOAX00800150	Ø80	Ø150	213€
909-DWECOAX00800180	Ø80	Ø180	259€
909-DWECOAX01000130	Ø100	Ø130	160€
909-DWECOAX01000150	Ø100	Ø150	206€
909-DWECOAX01000180	Ø100	Ø180	250€
909-DWECOAX01000200	Ø100	Ø200	283€
909-DWECOAX01300150	Ø130	Ø150	187€
909-DWECOAX01300180	Ø130	Ø180	237€
909-DWECOAX01300200	Ø130	Ø200	273€
909-DWECOAX01500180	Ø150	Ø180	219€
909-DWECOAX01500200	Ø150	Ø200	258€
909-DWECOAX01800200	Ø180	Ø200	236€

## AMPLIACIONES EXCÉNTRICAS

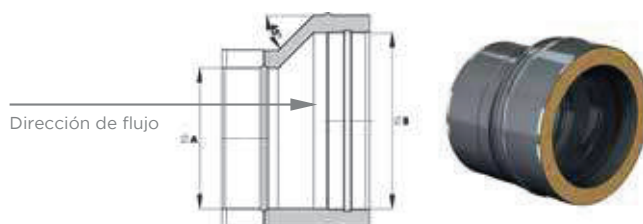

CÓDIGO	Ø A	Ø B	€
909-DWECOAX00800100	Ø80	Ø100	160€
909-DWECOAX00800130	Ø80	Ø130	230€
909-DWECOAX00800150	Ø80	Ø150	278€
909-DWECOAX00800180	Ø80	Ø180	340€
909-DWECOAX00800200	Ø80	Ø200	386€
909-DWECOAX01000130	Ø100	Ø130	208€
909-DWECOAX01000150	Ø100	Ø150	267€
909-DWECOAX01000180	Ø100	Ø180	321€
909-DWECOAX01000200	Ø100	Ø200	368€
909-DWECOAX01300150	Ø130	Ø150	240€
909-DWECOAX01300180	Ø130	Ø180	310€
909-DWECOAX01300200	Ø130	Ø200	349€
909-DWECOAX01500180	Ø150	Ø180	281€
909-DWECOAX01500200	Ø150	Ø200	338€
909-DWECOAX01800200	Ø180	Ø200	308€

## REDUCCIONES

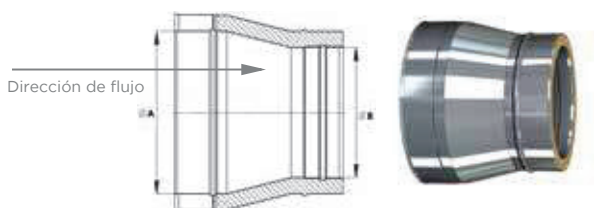

CÓDIGO	Ø A	Ø B	€
909-DWECOR01000080	Ø100	Ø80	124€
909-DWECOR01300080	Ø130	Ø80	177€
909-DWECOR01300100	Ø130	Ø100	160€
909-DWECOR01500080	Ø150	Ø80	213€
909-DWECOR01500100	Ø150	Ø100	206€
909-DWECOR01500130	Ø150	Ø130	187€
909-DWECOR01800080	Ø180	Ø80	259€
909-DWECOR01800100	Ø180	Ø100	250€
909-DWECOR01800130	Ø180	Ø130	237€
909-DWECOR01800150	Ø180	Ø150	219€
909-DWECOR02000100	Ø200	Ø100	283€
909-DWECOR02000130	Ø200	Ø130	273€
909-DWECOR02000150	Ø200	Ø150	258€
909-DWECOR02000180	Ø200	Ø180	236€

## REDUCCIONES EXCÉNTRICAS

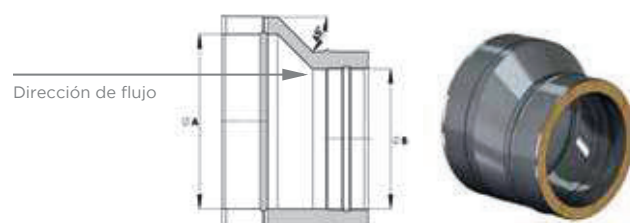

CÓDIGO	Ø A	Ø B	€
909-DWECORX01000080	Ø100	Ø80	160€
909-DWECORX01300080	Ø130	Ø80	230€
909-DWECORX01300100	Ø130	Ø100	208€
909-DWECORX01500080	Ø150	Ø80	278€
909-DWECORX01500100	Ø150	Ø100	267€
909-DWECORX01500130	Ø150	Ø130	240€
909-DWECORX01800080	Ø180	Ø80	340€
909-DWECORX01800100	Ø180	Ø100	321€
909-DWECORX01800130	Ø180	Ø130	310€
909-DWECORX01800150	Ø180	Ø150	281€
909-DWECORX02000080	Ø200	Ø80	386€
909-DWECORX02000100	Ø200	Ø100	368€
909-DWECORX02000130	Ø200	Ø130	349€
909-DWECORX02000150	Ø200	Ø150	338€
909-DWECORX02000180	Ø200	Ø180	308€